

Figure 1.3.3 : An illustration of the 3+1 decomposition of  $\underline{\underline{J}}$  given in Eq. (1.3.21). One spatial dimension, and densities and orientations in that dimension, has been suppressed.

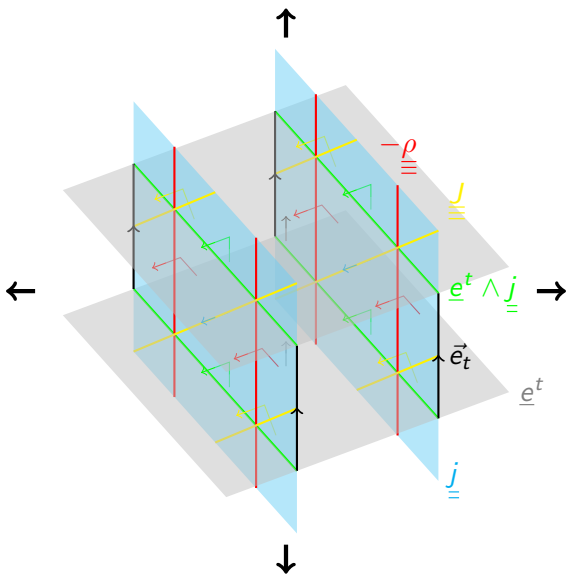

Figure 1.3.3 : An illustration of the 3+1 decomposition of  $\underline{\underline{J}}$  given in Eq. (1.3.21). One spatial dimension, and densities and orientations in that dimension, has been suppressed.

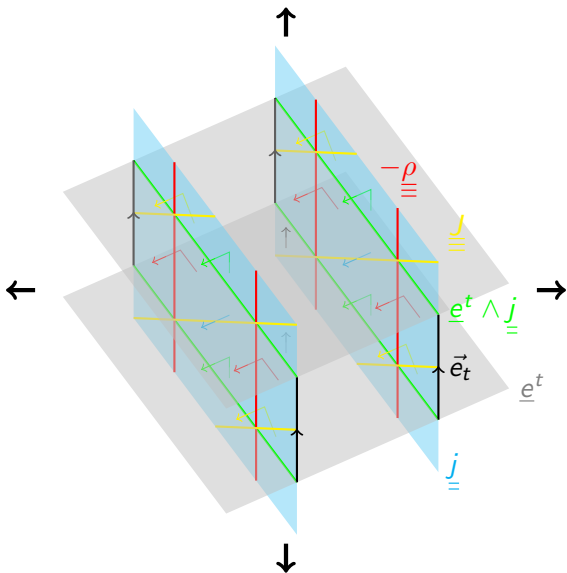

Figure 1.3.3 : An illustration of the 3+1 decomposition of  $\underline{J}$  given in Eq. (1.3.21). One spatial dimension, and densities and orientations in that dimension, has been suppressed.

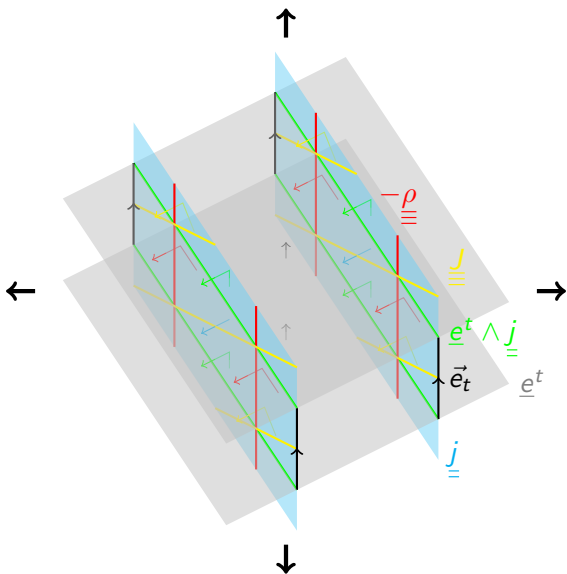

Figure 1.3.3 : An illustration of the 3+1 decomposition of  $\underline{J}$  given in Eq. (1.3.21). One spatial dimension, and densities and orientations in that dimension, has been suppressed.

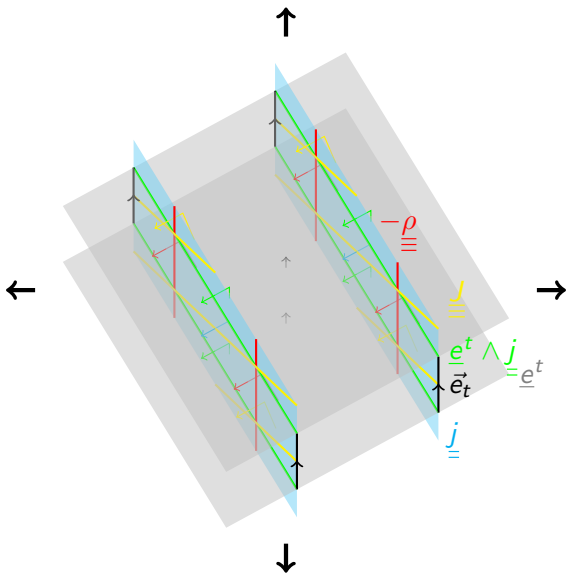

Figure 1.3.3 : An illustration of the 3+1 decomposition of  $\underline{j}$  given in Eq. (1.3.21). One spatial dimension, and densities and orientations in that dimension, has been suppressed.

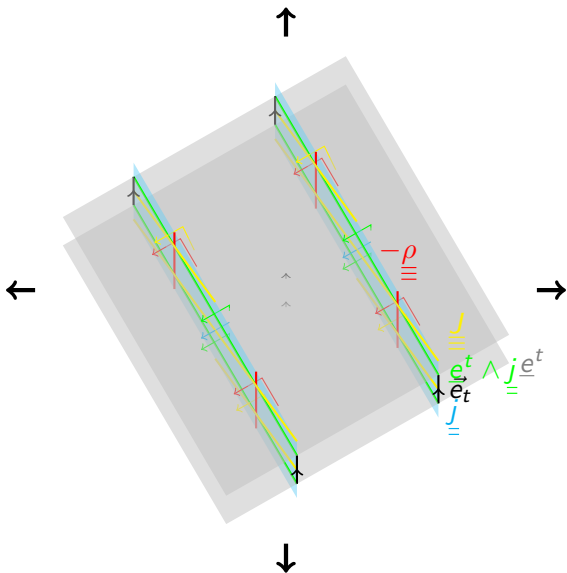

Figure 1.3.3 : An illustration of the 3+1 decomposition of  $\underline{\underline{J}}$  given in Eq. (1.3.21). One spatial dimension, and densities and orientations in that dimension, has been suppressed.

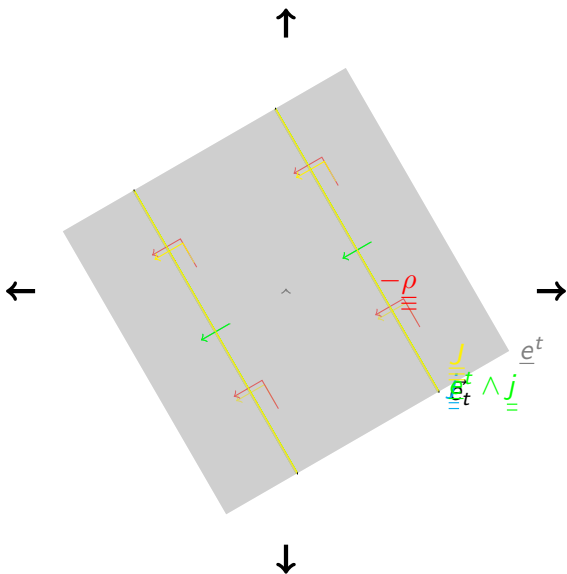

Figure 1.3.3 : An illustration of the 3+1 decomposition of  $\underline{J}$  given in Eq. (1.3.21). One spatial dimension, and densities and orientations in that dimension, has been suppressed.

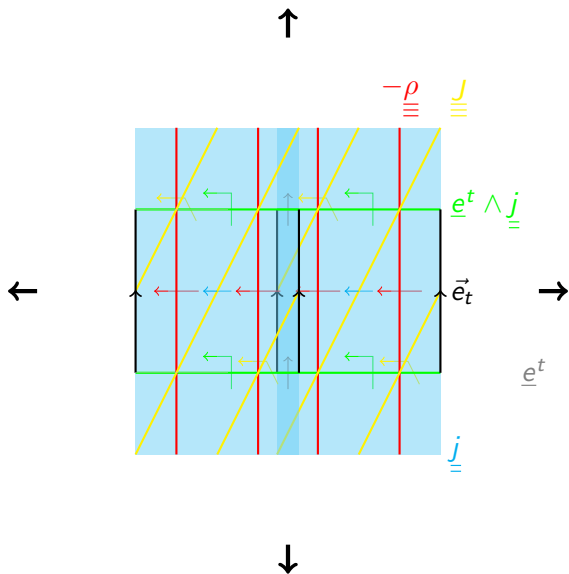

Figure 1.3.3 : An illustration of the 3+1 decomposition of  $\underline{J}$  given in Eq. (1.3.21). One spatial dimension, and densities and orientations in that dimension, has been suppressed.



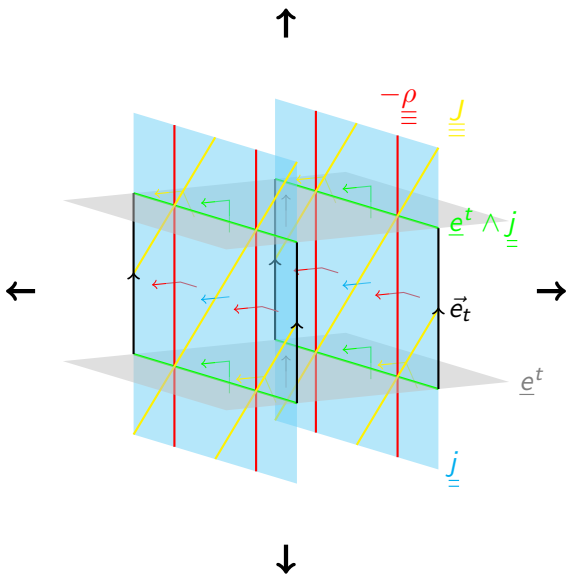

Figure 1.3.3 : An illustration of the 3+1 decomposition of  $\underline{\underline{J}}$  given in Eq. (1.3.21). One spatial dimension, and densities and orientations in that dimension, has been suppressed.

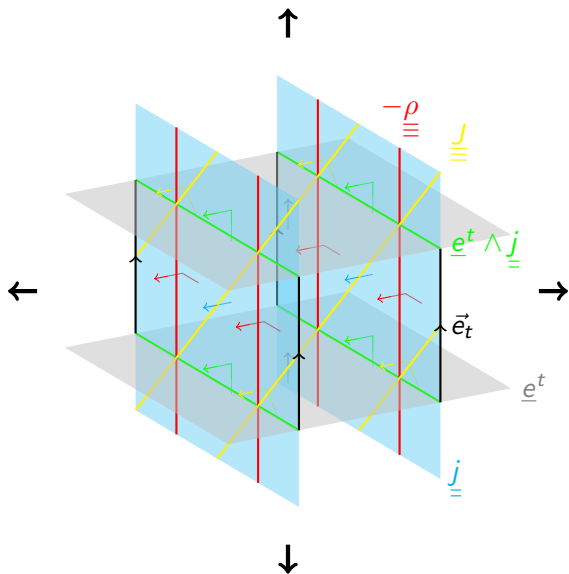

Figure 1.3.3 : An illustration of the 3+1 decomposition of  $\underline{\underline{J}}$  given in Eq. (1.3.21). One spatial dimension, and densities and orientations in that dimension, has been suppressed.

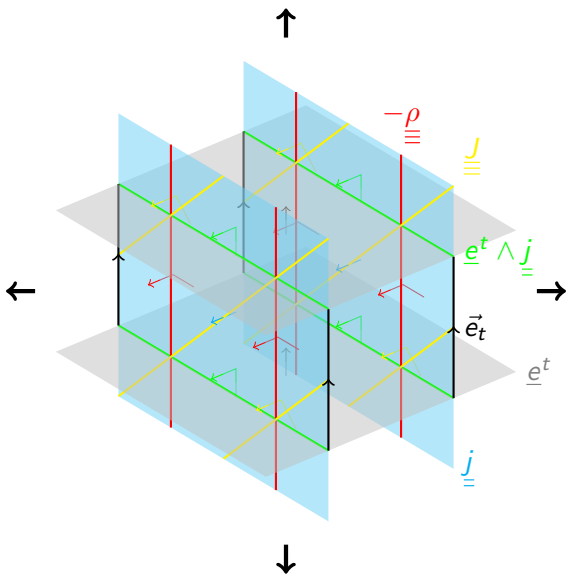

Figure 1.3.3 : An illustration of the 3+1 decomposition of  $\underline{\underline{J}}$  given in Eq. (1.3.21). One spatial dimension, and densities and orientations in that dimension, has been suppressed.

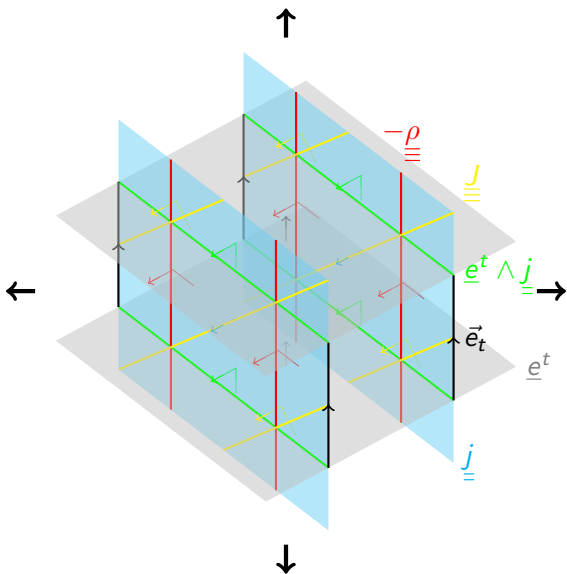

Figure 1.3.3 : An illustration of the 3+1 decomposition of  $\underline{J}$  given in Eq. (1.3.21). One spatial dimension, and densities and orientations in that dimension, has been suppressed.

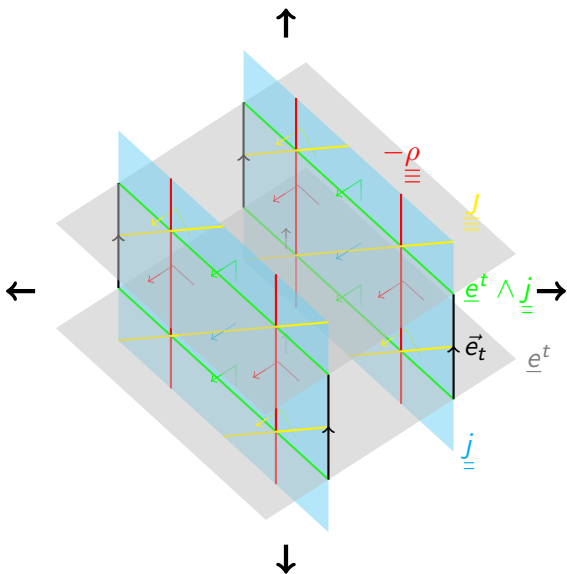

Figure 1.3.3 : An illustration of the 3+1 decomposition of  $\underline{\underline{J}}$  given in Eq. (1.3.21). One spatial dimension, and densities and orientations in that dimension, has been suppressed.

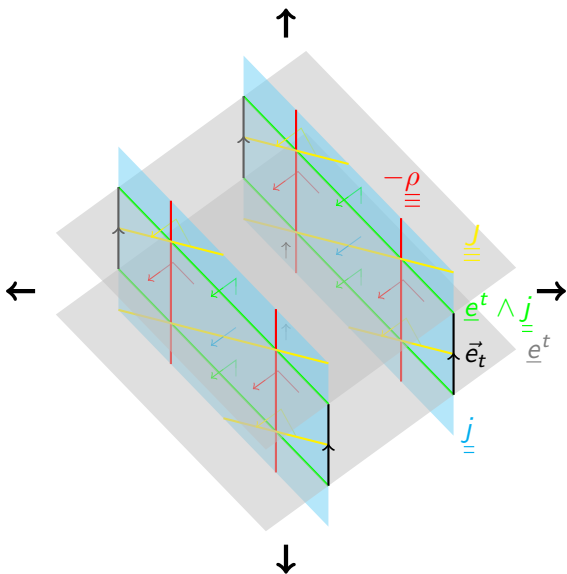

Figure 1.3.3 : An illustration of the 3+1 decomposition of  $\underline{j}$  given in Eq. (1.3.21). One spatial dimension, and densities and orientations in that dimension, has been suppressed.

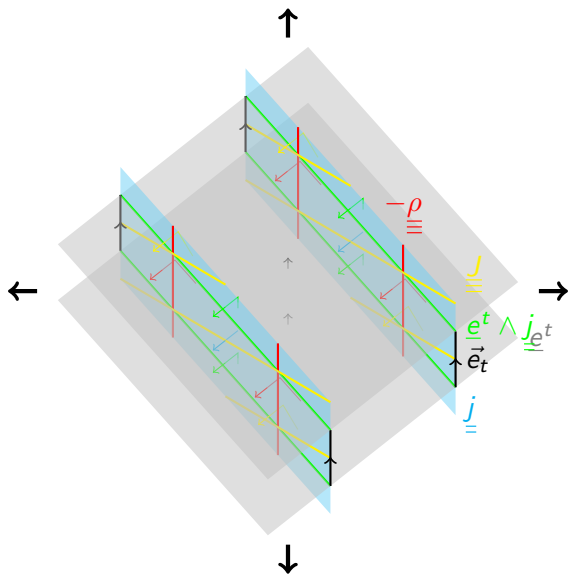

Figure 1.3.3 : An illustration of the 3+1 decomposition of  $\underline{\underline{J}}$  given in Eq. (1.3.21). One spatial dimension, and densities and orientations in that dimension, has been suppressed.

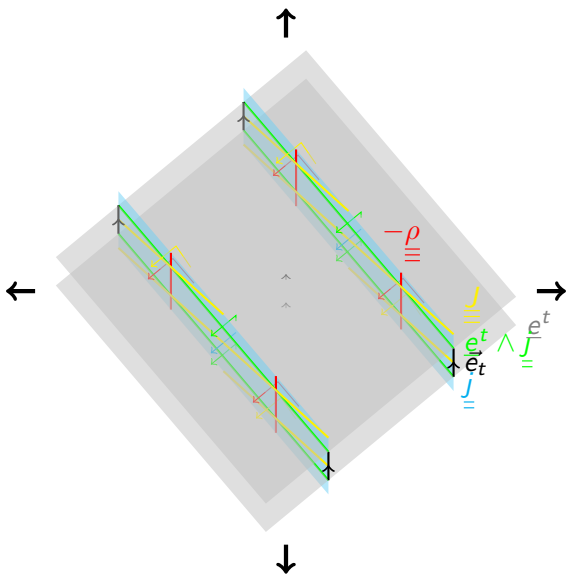

Figure 1.3.3 : An illustration of the 3+1 decomposition of  $\underline{\underline{J}}$  given in Eq. (1.3.21). One spatial dimension, and densities and orientations in that dimension, has been suppressed.



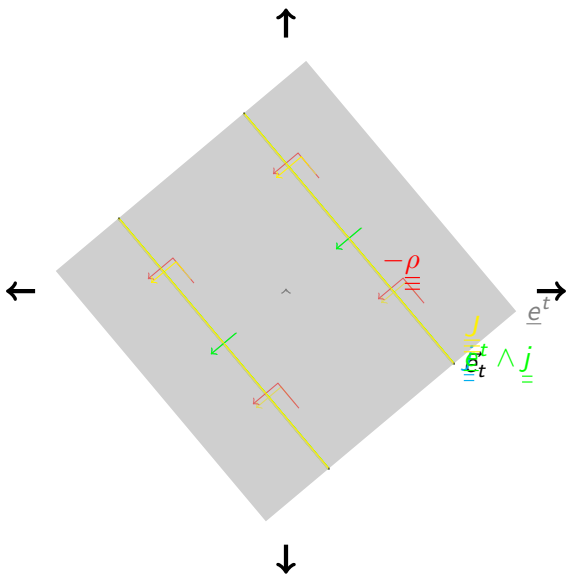

Figure 1.3.3 : An illustration of the 3+1 decomposition of  $\underline{J}$  given in Eq. (1.3.21). One spatial dimension, and densities and orientations in that dimension, has been suppressed.

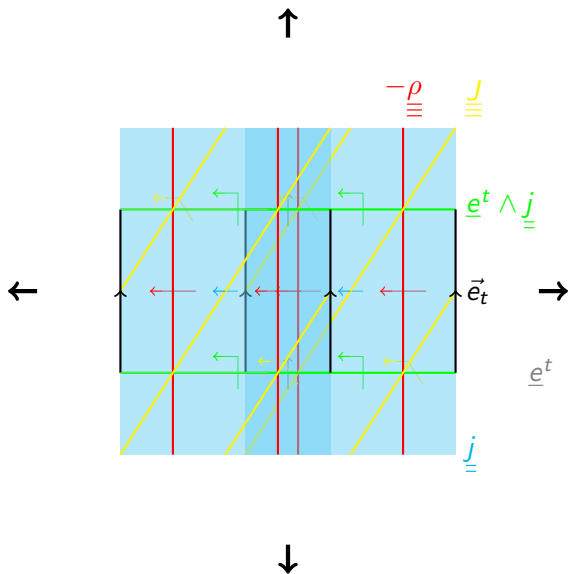

Figure 1.3.3 : An illustration of the 3+1 decomposition of  $\underline{J}$  given in Eq. (1.3.21). One spatial dimension, and densities and orientations in that dimension, has been suppressed.

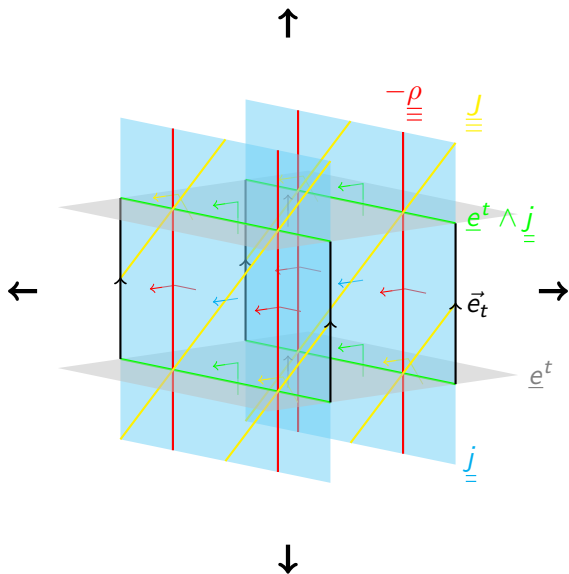

Figure 1.3.3 : An illustration of the 3+1 decomposition of  $\underline{\underline{J}}$  given in Eq. (1.3.21). One spatial dimension, and densities and orientations in that dimension, has been suppressed.

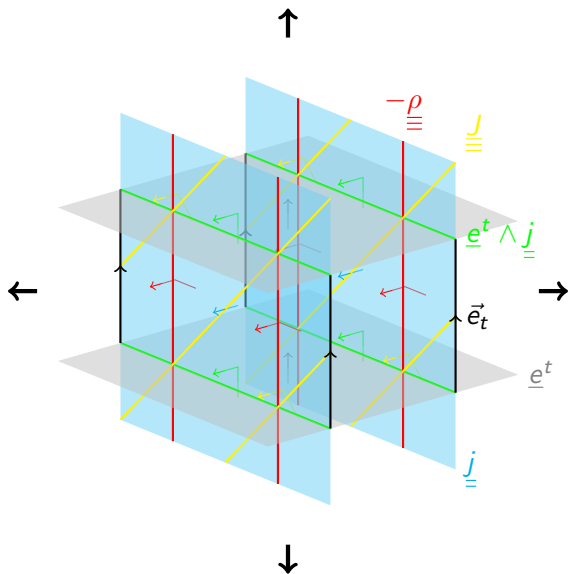

Figure 1.3.3 : An illustration of the 3+1 decomposition of  $\underline{J}$  given in Eq. (1.3.21). One spatial dimension, and densities and orientations in that dimension, has been suppressed.

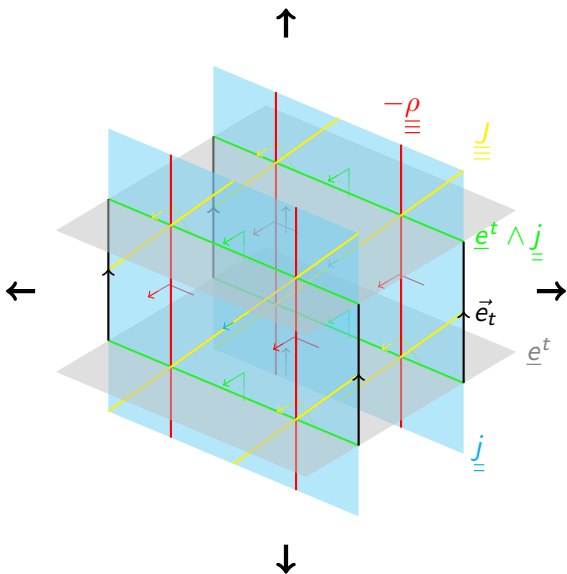

Figure 1.3.3 : An illustration of the 3+1 decomposition of  $\underline{J}$  given in Eq. (1.3.21). One spatial dimension, and densities and orientations in that dimension, has been suppressed.

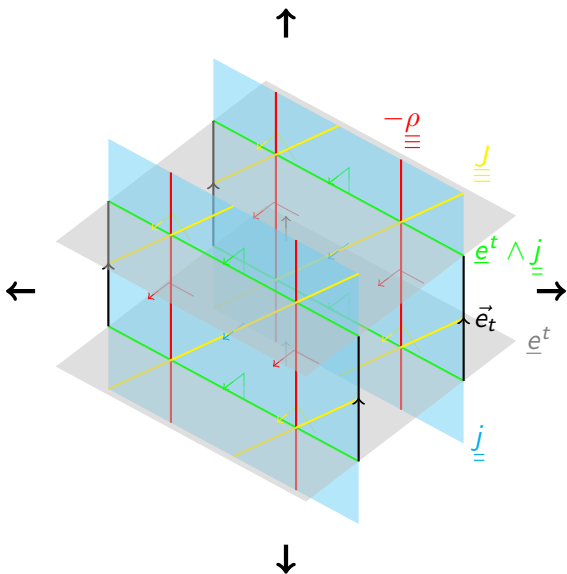

Figure 1.3.3 : An illustration of the 3+1 decomposition of  $\underline{\underline{J}}$  given in Eq. (1.3.21). One spatial dimension, and densities and orientations in that dimension, has been suppressed.

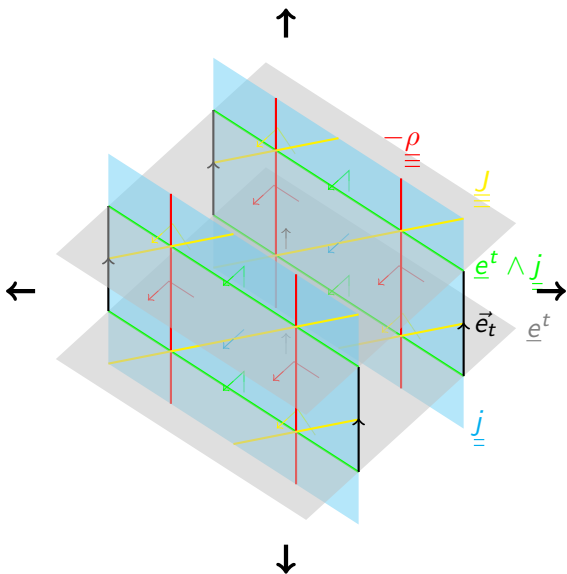

Figure 1.3.3 : An illustration of the 3+1 decomposition of  $\underline{\underline{J}}$  given in Eq. (1.3.21). One spatial dimension, and densities and orientations in that dimension, has been suppressed.





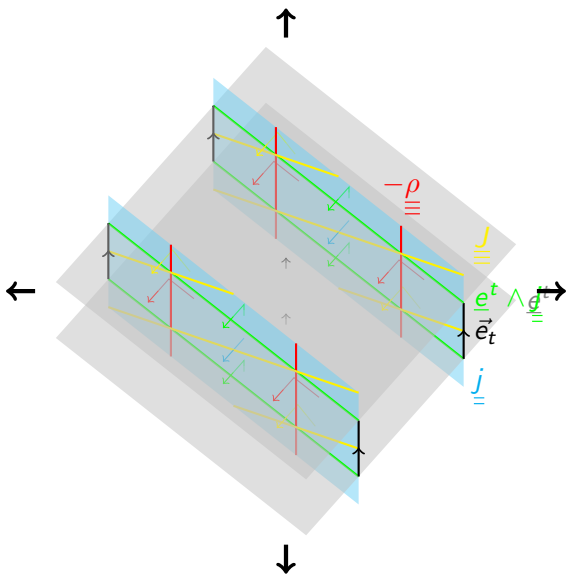

Figure 1.3.3 : An illustration of the 3+1 decomposition of  $\underline{\underline{J}}$  given in Eq. (1.3.21). One spatial dimension, and densities and orientations in that dimension, has been suppressed.

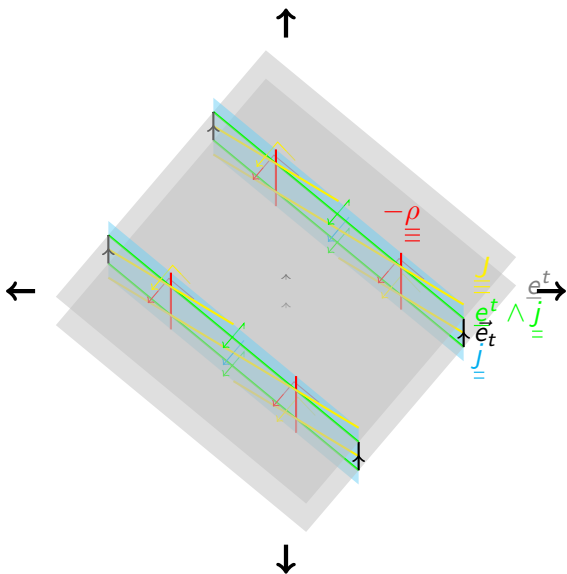

Figure 1.3.3 : An illustration of the 3+1 decomposition of  $\underline{J}$  given in Eq. (1.3.21). One spatial dimension, and densities and orientations in that dimension, has been suppressed.

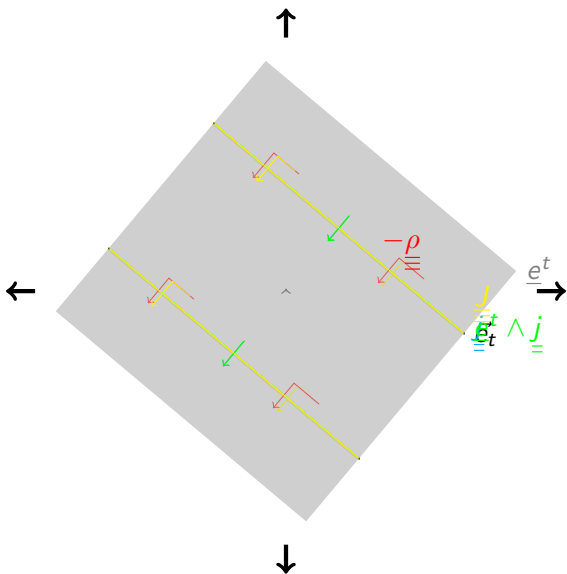

Figure 1.3.3 : An illustration of the 3+1 decomposition of  $\underline{\underline{J}}$  given in Eq. (1.3.21). One spatial dimension, and densities and orientations in that dimension, has been suppressed.

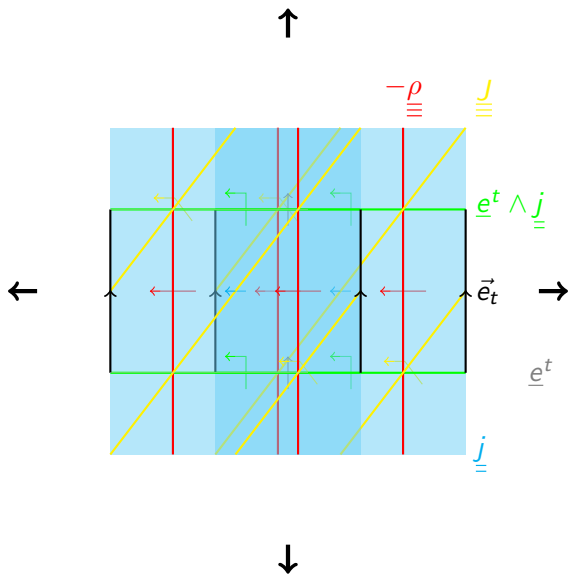

Figure 1.3.3 : An illustration of the 3+1 decomposition of  $\underline{\underline{J}}$  given in Eq. (1.3.21). One spatial dimension, and densities and orientations in that dimension, has been suppressed.

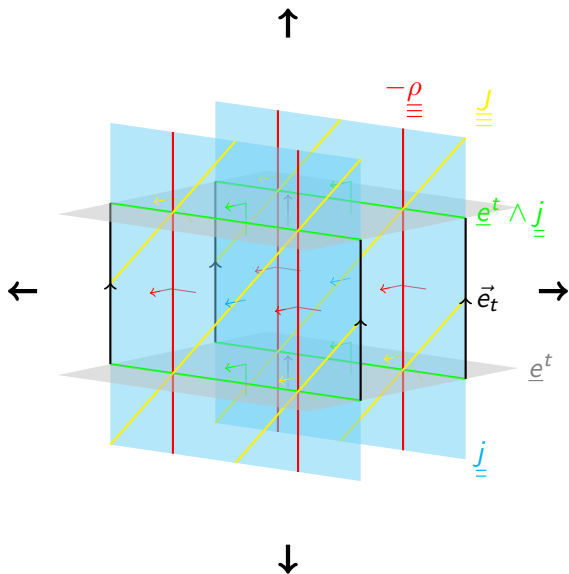

Figure 1.3.3 : An illustration of the 3+1 decomposition of  $\underline{\underline{J}}$  given in Eq. (1.3.21). One spatial dimension, and densities and orientations in that dimension, has been suppressed.

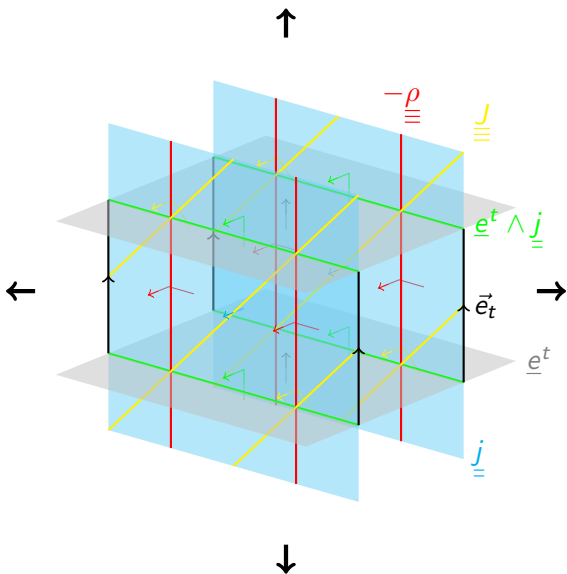

Figure 1.3.3 : An illustration of the 3+1 decomposition of  $\underline{J}$  given in Eq. (1.3.21). One spatial dimension, and densities and orientations in that dimension, has been suppressed.

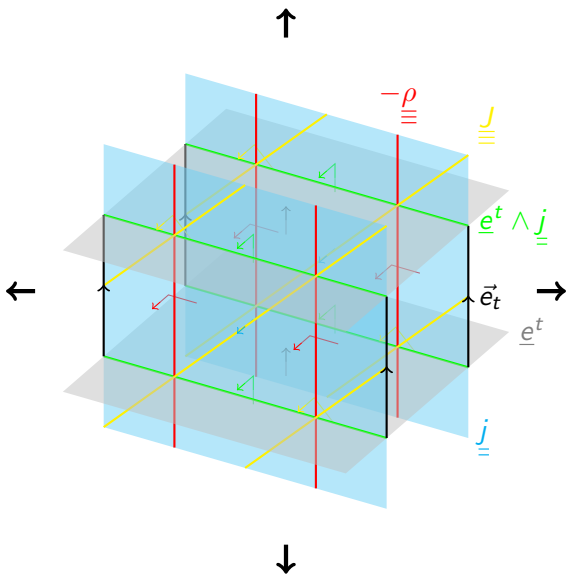

Figure 1.3.3 : An illustration of the 3+1 decomposition of  $\underline{J}$  given in Eq. (1.3.21). One spatial dimension, and densities and orientations in that dimension, has been suppressed.

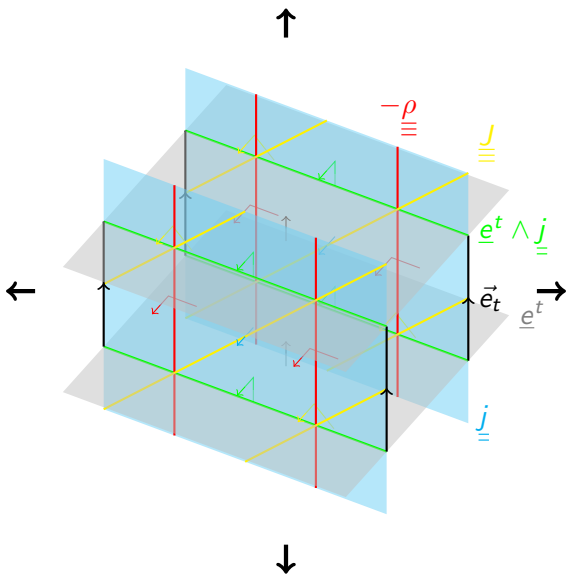

Figure 1.3.3 : An illustration of the 3+1 decomposition of  $\underline{J}$  given in Eq. (1.3.21). One spatial dimension, and densities and orientations in that dimension, has been suppressed.



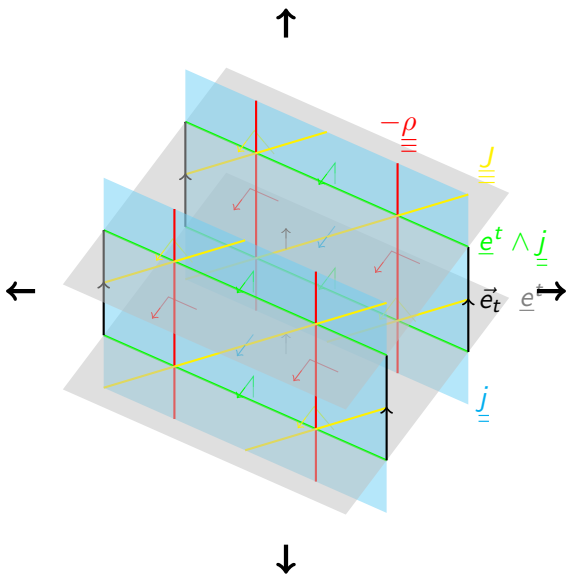

Figure 1.3.3 : An illustration of the 3+1 decomposition of  $\underline{\underline{J}}$  given in Eq. (1.3.21). One spatial dimension, and densities and orientations in that dimension, has been suppressed.

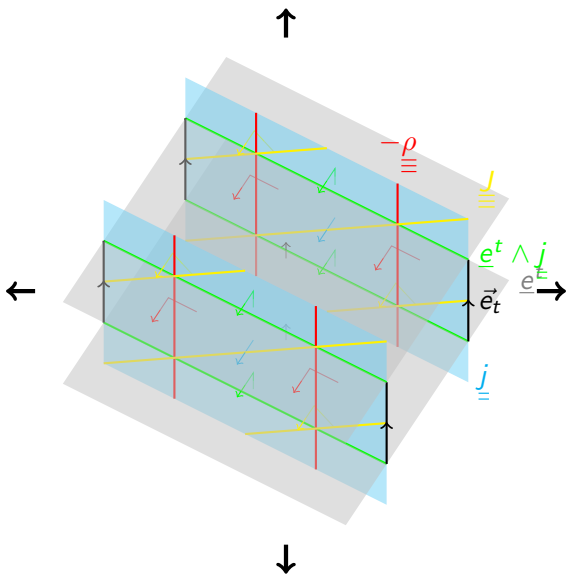

Figure 1.3.3 : An illustration of the 3+1 decomposition of  $\underline{\underline{J}}$  given in Eq. (1.3.21). One spatial dimension, and densities and orientations in that dimension, has been suppressed.

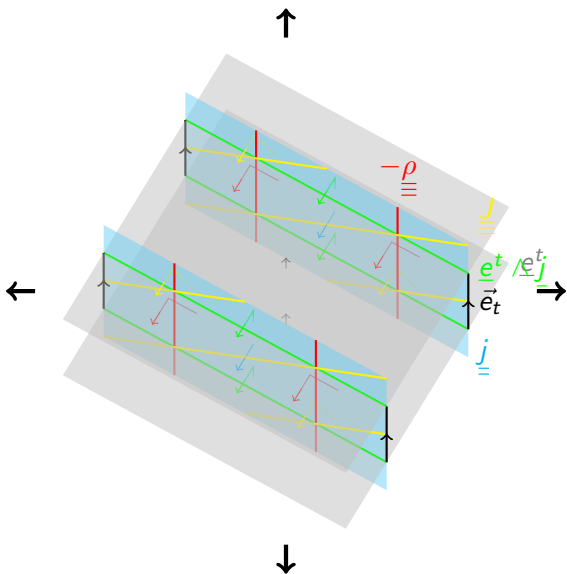

Figure 1.3.3 : An illustration of the 3+1 decomposition of  $\underline{J}$  given in Eq. (1.3.21). One spatial dimension, and densities and orientations in that dimension, has been suppressed.

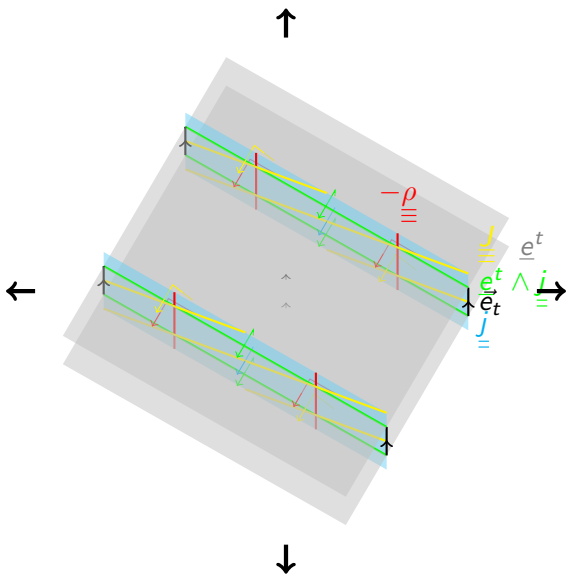

Figure 1.3.3 : An illustration of the 3+1 decomposition of  $\underline{\underline{J}}$  given in Eq. (1.3.21). One spatial dimension, and densities and orientations in that dimension, has been suppressed.

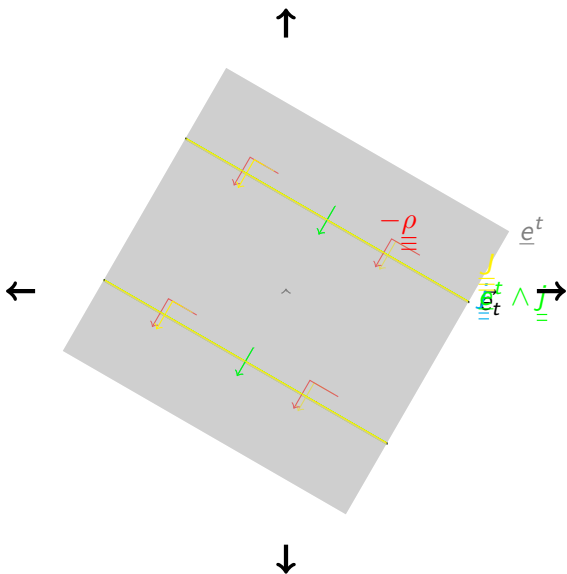

Figure 1.3.3 : An illustration of the 3+1 decomposition of  $\underline{J}$  given in Eq. (1.3.21). One spatial dimension, and densities and orientations in that dimension, has been suppressed.

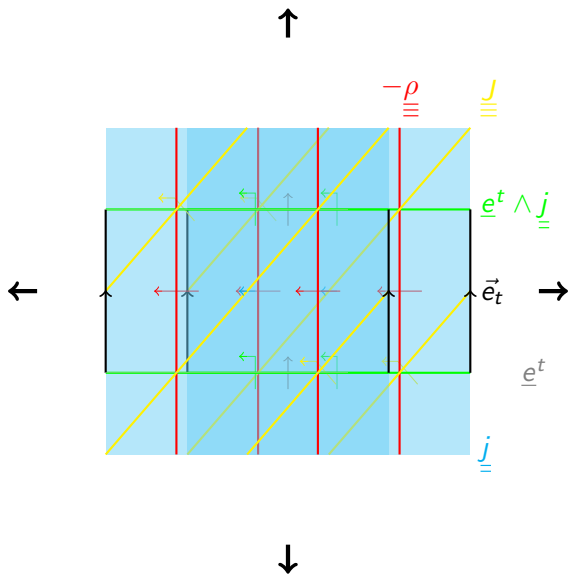

Figure 1.3.3 : An illustration of the 3+1 decomposition of  $\underline{J}$  given in Eq. (1.3.21). One spatial dimension, and densities and orientations in that dimension, has been suppressed.

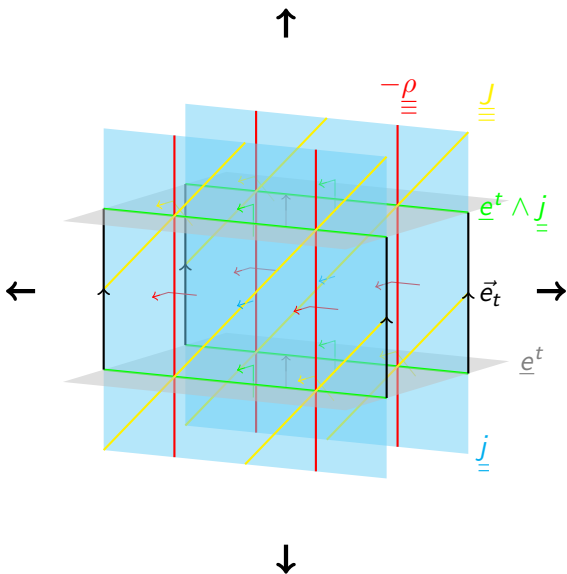

Figure 1.3.3 : An illustration of the 3+1 decomposition of  $\underline{J}$  given in Eq. (1.3.21). One spatial dimension, and densities and orientations in that dimension, has been suppressed.

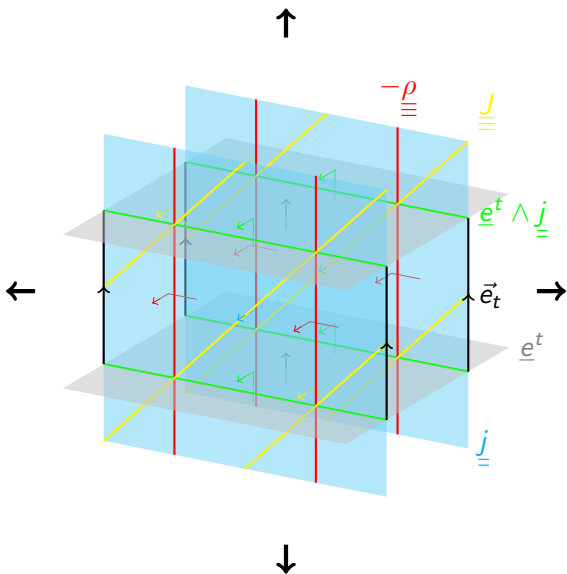

Figure 1.3.3 : An illustration of the 3+1 decomposition of  $\underline{J}$  given in Eq. (1.3.21). One spatial dimension, and densities and orientations in that dimension, has been suppressed.



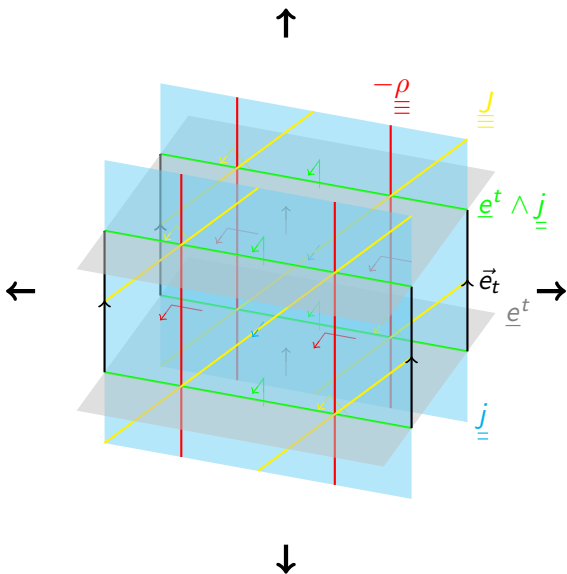

Figure 1.3.3 : An illustration of the 3+1 decomposition of  $\underline{\underline{J}}$  given in Eq. (1.3.21). One spatial dimension, and densities and orientations in that dimension, has been suppressed.

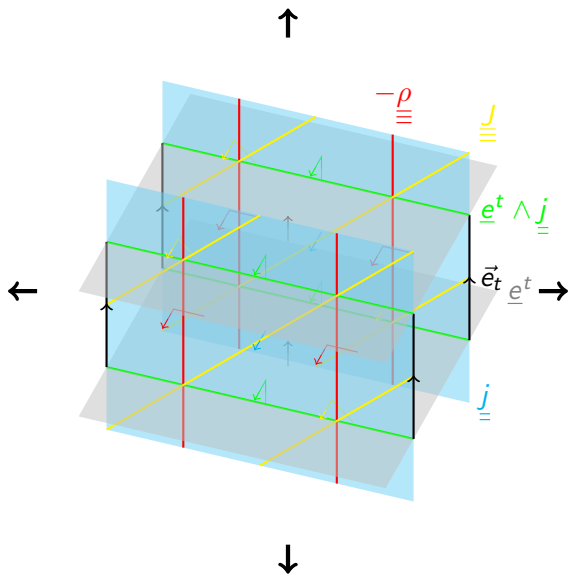

Figure 1.3.3 : An illustration of the 3+1 decomposition of  $\underline{\underline{J}}$  given in Eq. (1.3.21). One spatial dimension, and densities and orientations in that dimension, has been suppressed.

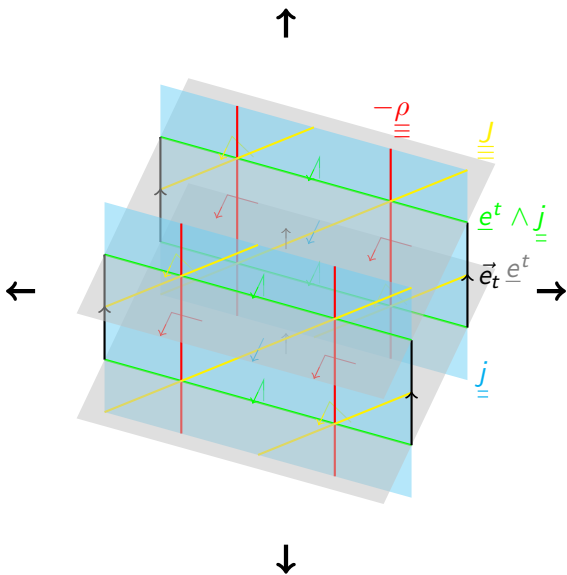

Figure 1.3.3 : An illustration of the 3+1 decomposition of  $\underline{J}$  given in Eq. (1.3.21). One spatial dimension, and densities and orientations in that dimension, has been suppressed.

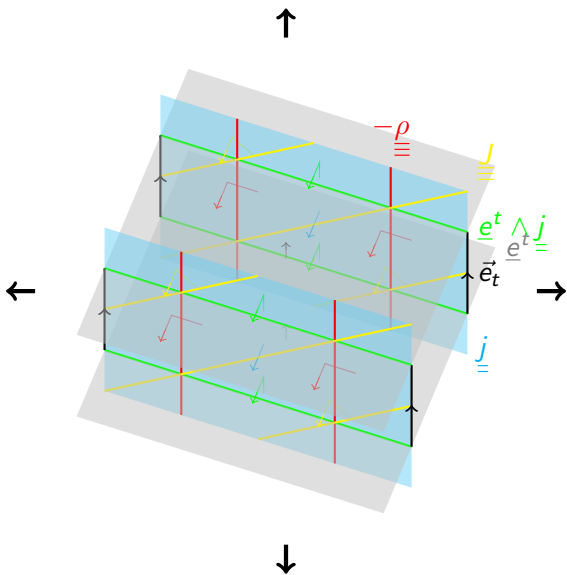

Figure 1.3.3 : An illustration of the 3+1 decomposition of  $\underline{\underline{J}}$  given in Eq. (1.3.21). One spatial dimension, and densities and orientations in that dimension, has been suppressed.

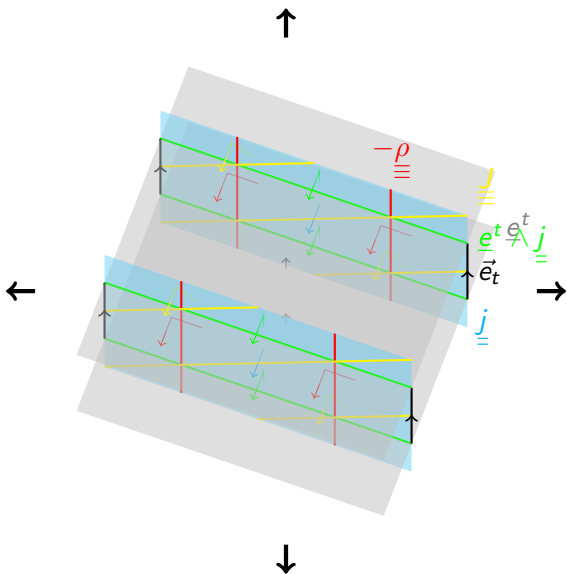

Figure 1.3.3 : An illustration of the 3+1 decomposition of  $\underline{J}$  given in Eq. (1.3.21). One spatial dimension, and densities and orientations in that dimension, has been suppressed.

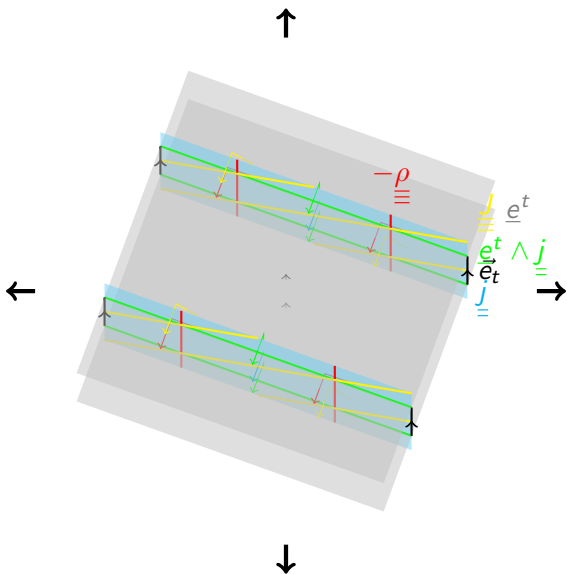

Figure 1.3.3 : An illustration of the 3+1 decomposition of  $\underline{\underline{J}}$  given in Eq. (1.3.21). One spatial dimension, and densities and orientations in that dimension, has been suppressed.

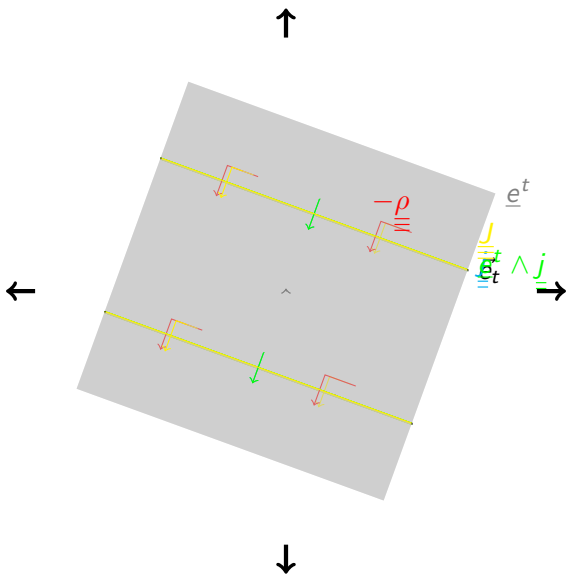

Figure 1.3.3 : An illustration of the 3+1 decomposition of  $\underline{\underline{J}}$  given in Eq. (1.3.21). One spatial dimension, and densities and orientations in that dimension, has been suppressed.

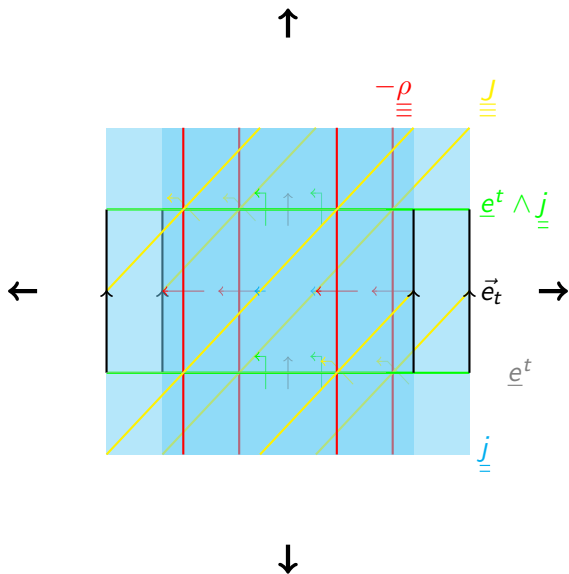

Figure 1.3.3 : An illustration of the 3+1 decomposition of  $\underline{J}$  given in Eq. (1.3.21). One spatial dimension, and densities and orientations in that dimension, has been suppressed.



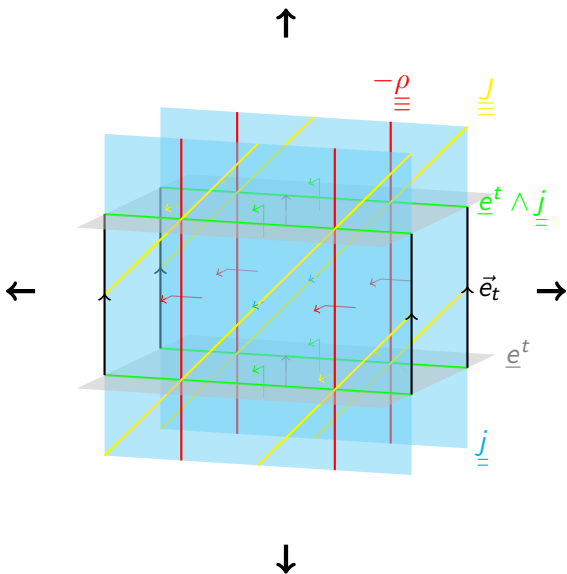

Figure 1.3.3 : An illustration of the 3+1 decomposition of  $\underline{\underline{J}}$  given in Eq. (1.3.21). One spatial dimension, and densities and orientations in that dimension, has been suppressed.

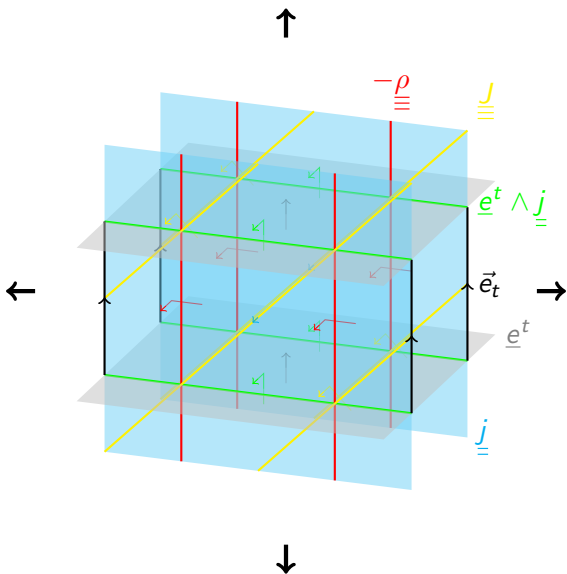

Figure 1.3.3 : An illustration of the 3+1 decomposition of  $\underline{J}$  given in Eq. (1.3.21). One spatial dimension, and densities and orientations in that dimension, has been suppressed.

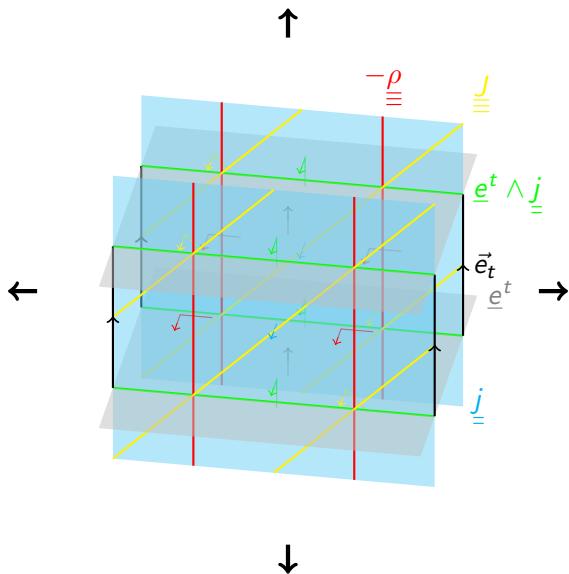

Figure 1.3.3 : An illustration of the 3+1 decomposition of  $\underline{\underline{J}}$  given in Eq. (1.3.21). One spatial dimension, and densities and orientations in that dimension, has been suppressed.

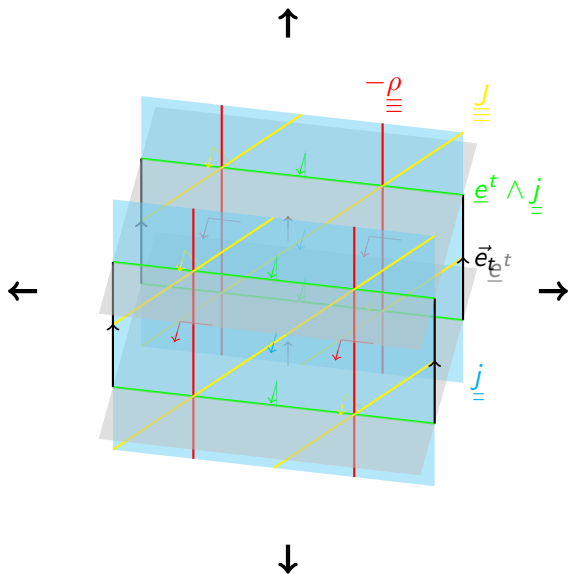

Figure 1.3.3 : An illustration of the 3+1 decomposition of  $\underline{\underline{J}}$  given in Eq. (1.3.21). One spatial dimension, and densities and orientations in that dimension, has been suppressed.

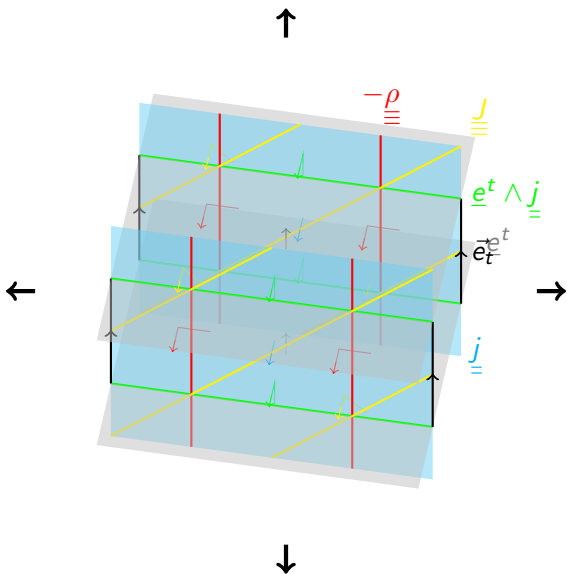

Figure 1.3.3 : An illustration of the 3+1 decomposition of  $\underline{J}$  given in Eq. (1.3.21). One spatial dimension, and densities and orientations in that dimension, has been suppressed.

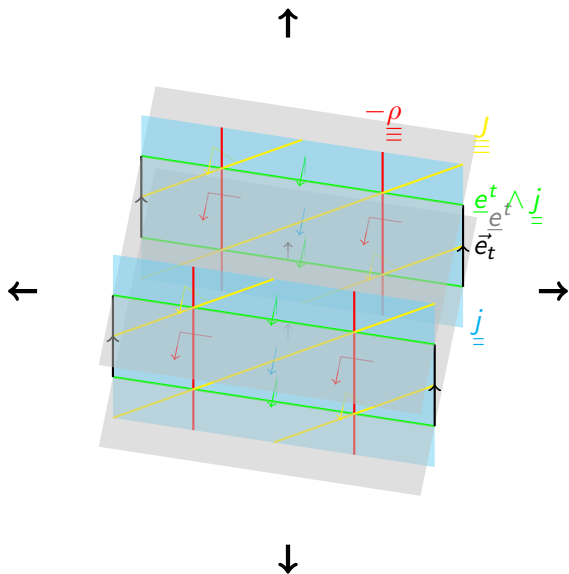

Figure 1.3.3 : An illustration of the 3+1 decomposition of  $\underline{J}$  given in Eq. (1.3.21). One spatial dimension, and densities and orientations in that dimension, has been suppressed.



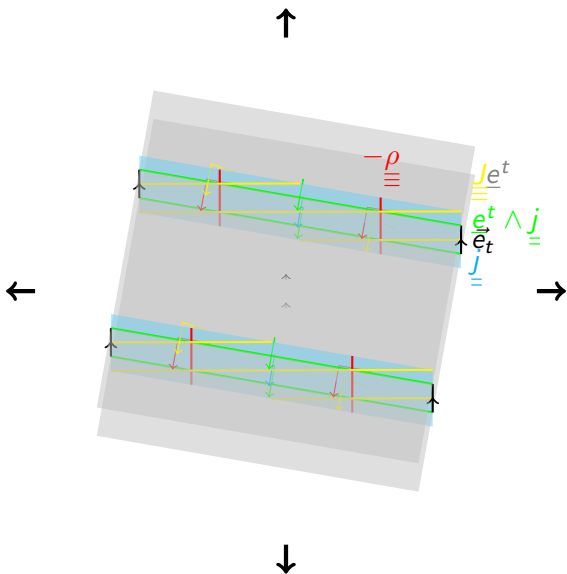

Figure 1.3.3 : An illustration of the 3+1 decomposition of  $\underline{\underline{J}}$  given in Eq. (1.3.21). One spatial dimension, and densities and orientations in that dimension, has been suppressed.



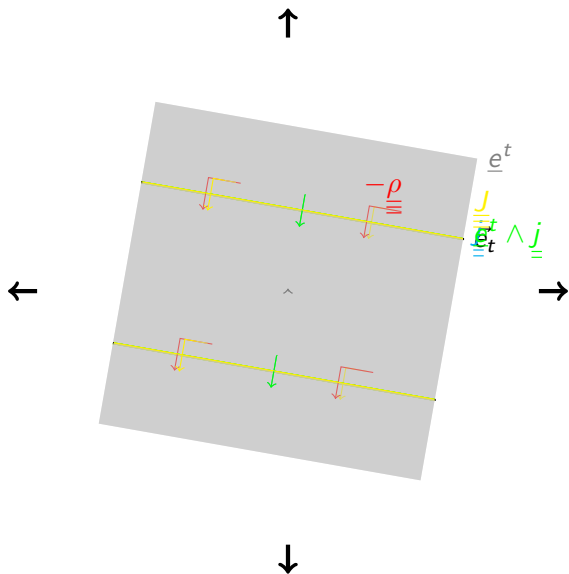

Figure 1.3.3 : An illustration of the 3+1 decomposition of  $\underline{\underline{J}}$  given in Eq. (1.3.21). One spatial dimension, and densities and orientations in that dimension, has been suppressed.

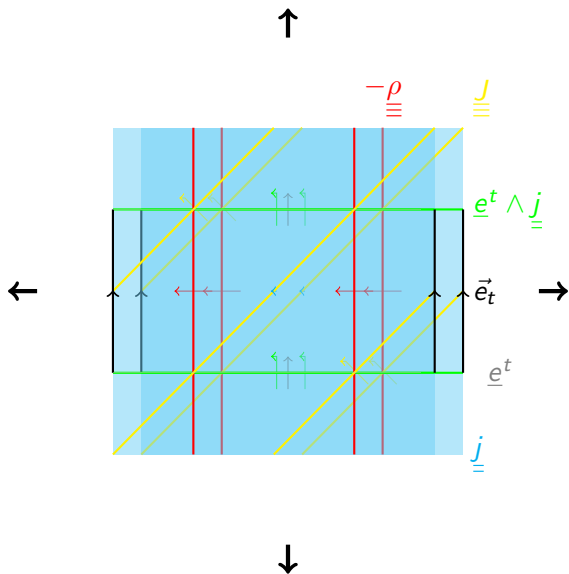

Figure 1.3.3 : An illustration of the 3+1 decomposition of  $\underline{j}$  given in Eq. (1.3.21). One spatial dimension, and densities and orientations in that dimension, has been suppressed.

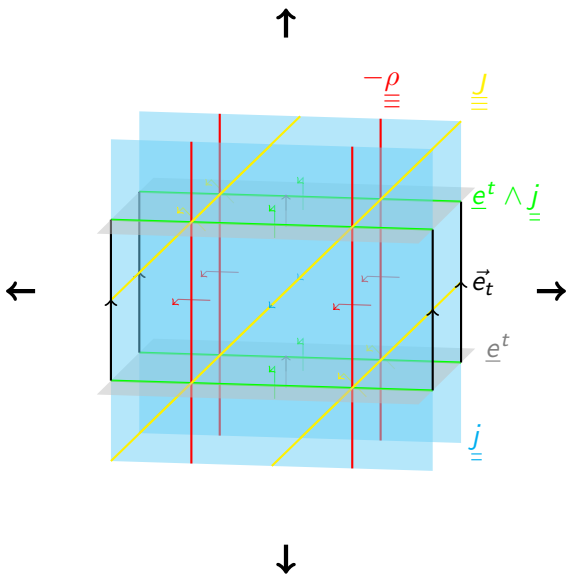

Figure 1.3.3 : An illustration of the 3+1 decomposition of  $\underline{\underline{J}}$  given in Eq. (1.3.21). One spatial dimension, and densities and orientations in that dimension, has been suppressed.

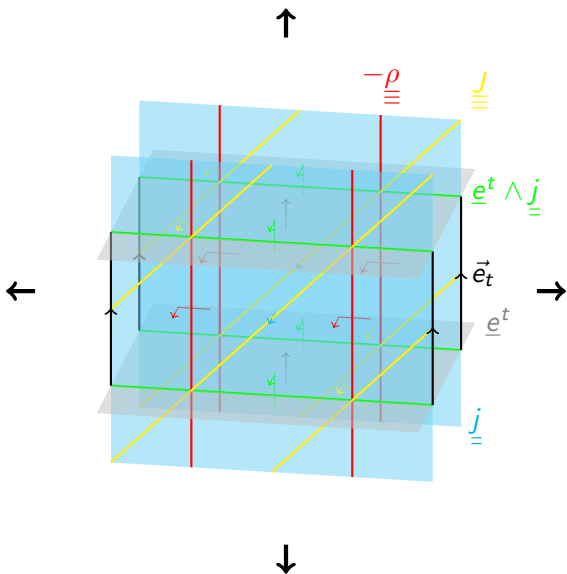

Figure 1.3.3 : An illustration of the 3+1 decomposition of  $\underline{J}$  given in Eq. (1.3.21). One spatial dimension, and densities and orientations in that dimension, has been suppressed.

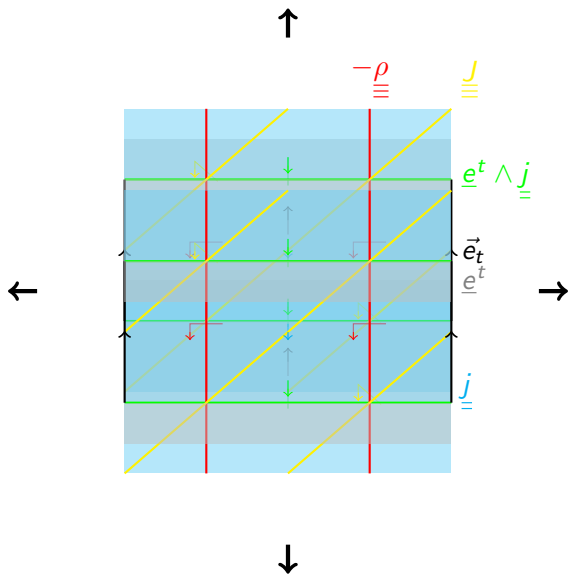

Figure 1.3.3 : An illustration of the 3+1 decomposition of  $\underline{\underline{J}}$  given in Eq. (1.3.21). One spatial dimension, and densities and orientations in that dimension, has been suppressed.

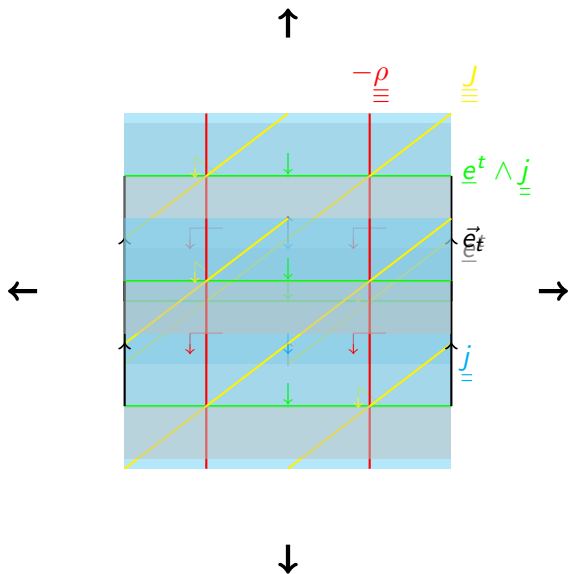

Figure 1.3.3 : An illustration of the 3+1 decomposition of  $\underline{J}$  given in Eq. (1.3.21). One spatial dimension, and densities and orientations in that dimension, has been suppressed.

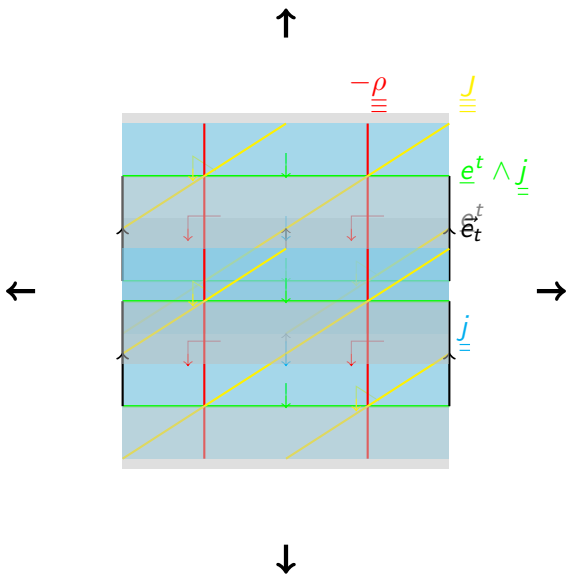

Figure 1.3.3 : An illustration of the 3+1 decomposition of  $\underline{J}$  given in Eq. (1.3.21). One spatial dimension, and densities and orientations in that dimension, has been suppressed.

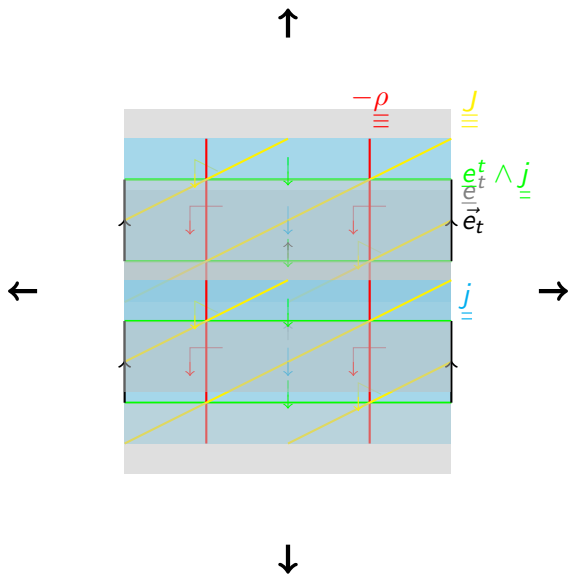

Figure 1.3.3 : An illustration of the 3+1 decomposition of  $\underline{\underline{J}}$  given in Eq. (1.3.21). One spatial dimension, and densities and orientations in that dimension, has been suppressed.



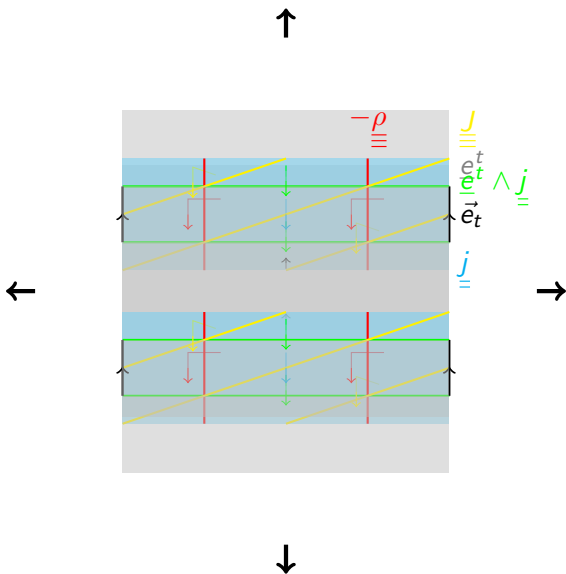

Figure 1.3.3 : An illustration of the 3+1 decomposition of  $\underline{J}$  given in Eq. (1.3.21). One spatial dimension, and densities and orientations in that dimension, has been suppressed.

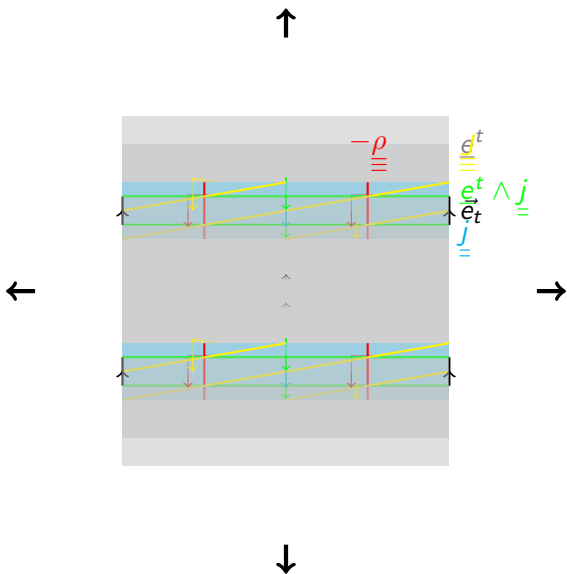

Figure 1.3.3 : An illustration of the 3+1 decomposition of  $\underline{J}$  given in Eq. (1.3.21). One spatial dimension, and densities and orientations in that dimension, has been suppressed.

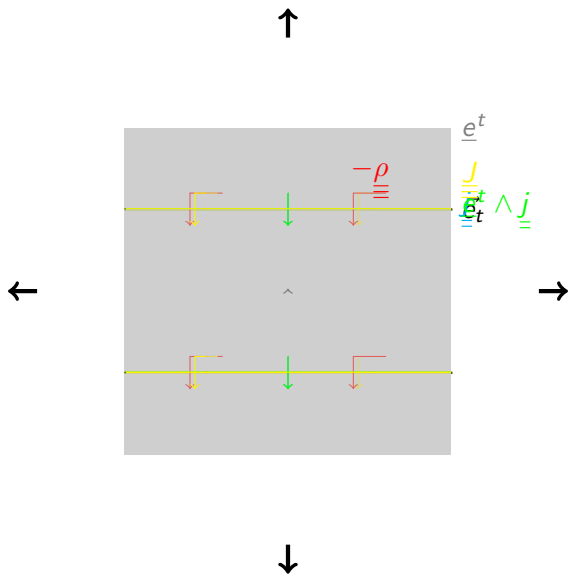

Figure 1.3.3 : An illustration of the 3+1 decomposition of  $\underline{\underline{J}}$  given in Eq. (1.3.21). One spatial dimension, and densities and orientations in that dimension, has been suppressed.

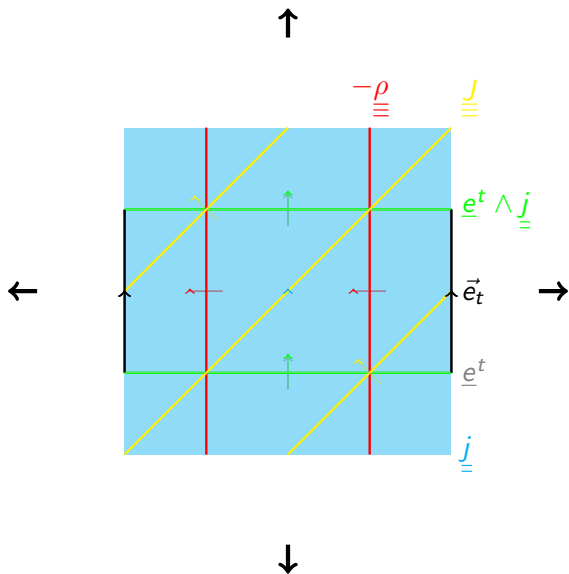

Figure 1.3.3 : An illustration of the 3+1 decomposition of  $\underline{\underline{J}}$  given in Eq. (1.3.21). One spatial dimension, and densities and orientations in that dimension, has been suppressed.



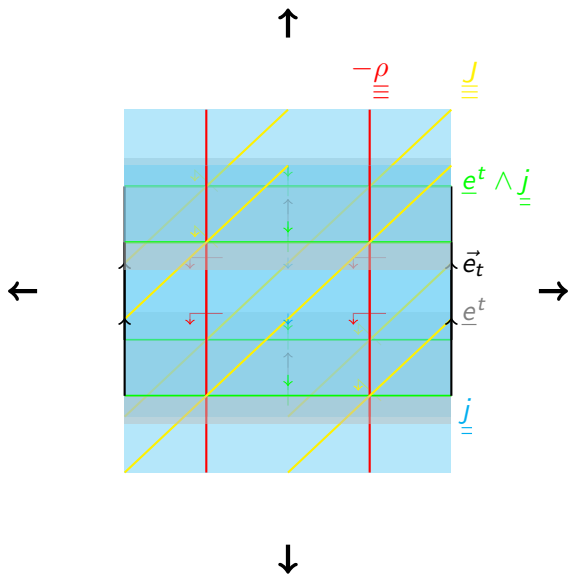

Figure 1.3.3 : An illustration of the 3+1 decomposition of  $\underline{J}$  given in Eq. (1.3.21). One spatial dimension, and densities and orientations in that dimension, has been suppressed.

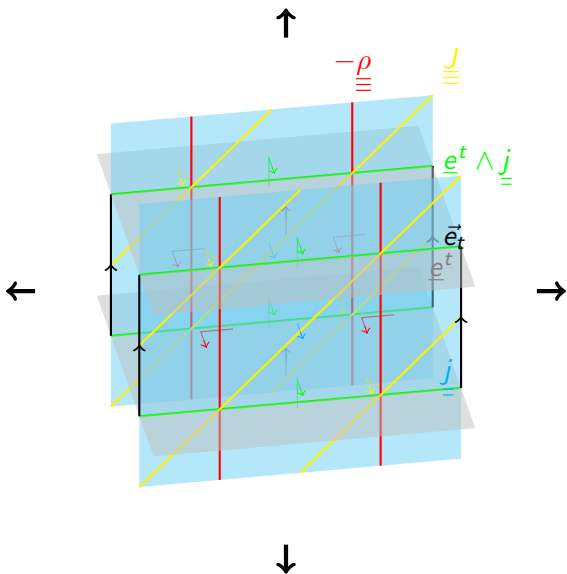

Figure 1.3.3 : An illustration of the 3+1 decomposition of  $\underline{J}$  given in Eq. (1.3.21). One spatial dimension, and densities and orientations in that dimension, has been suppressed.

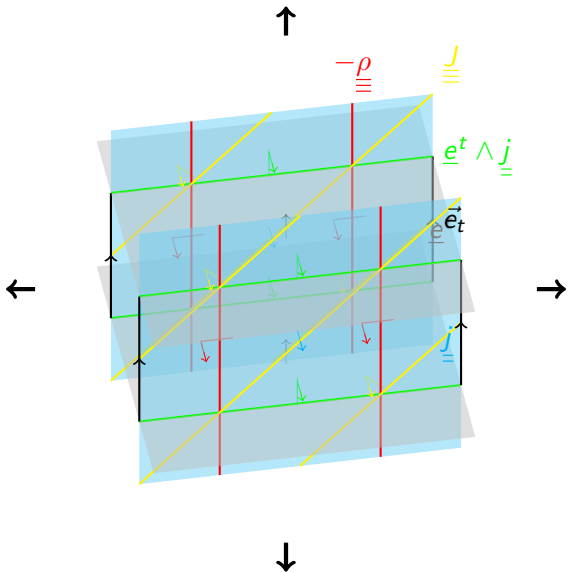

Figure 1.3.3 : An illustration of the 3+1 decomposition of  $\underline{J}$  given in Eq. (1.3.21). One spatial dimension, and densities and orientations in that dimension, has been suppressed.



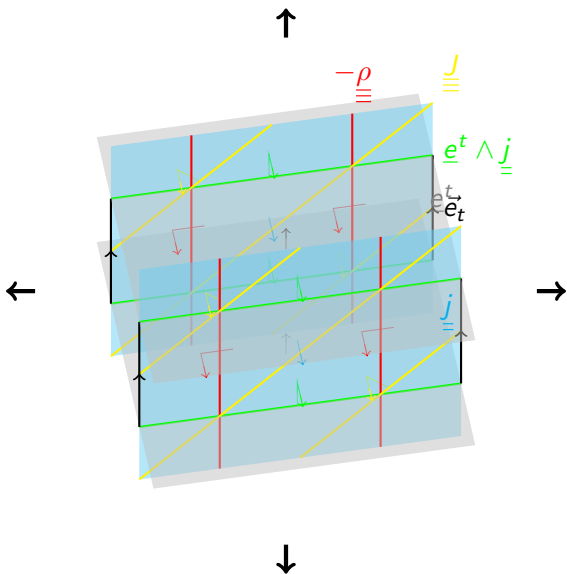

Figure 1.3.3 : An illustration of the 3+1 decomposition of  $\underline{J}$  given in Eq. (1.3.21). One spatial dimension, and densities and orientations in that dimension, has been suppressed.

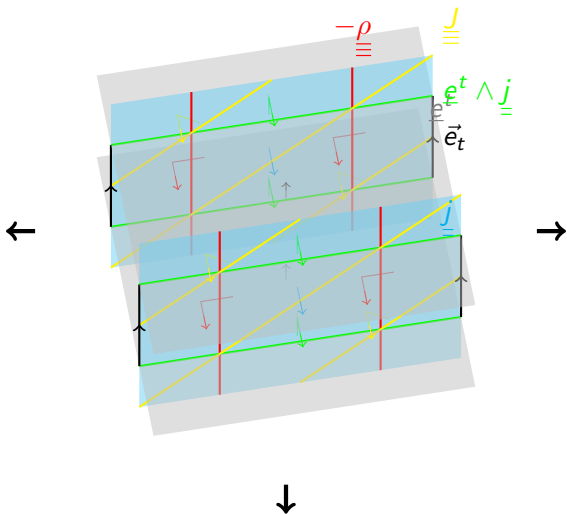

Figure 1.3.3 : An illustration of the 3+1 decomposition of  $\underline{J}$  given in Eq. (1.3.21). One spatial dimension, and densities and orientations in that dimension, has been suppressed.

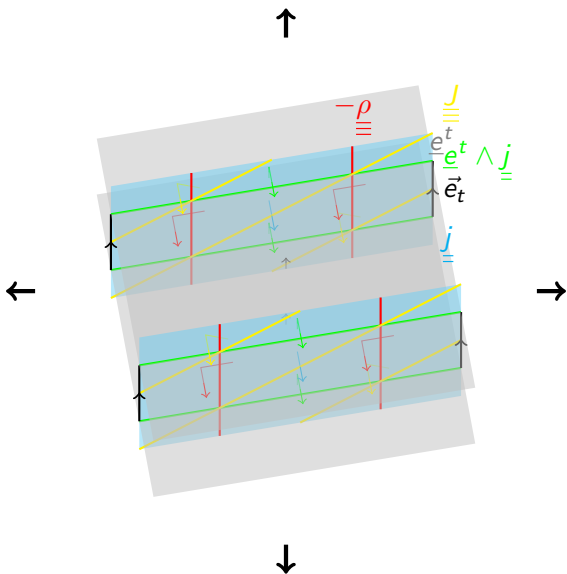

Figure 1.3.3 : An illustration of the 3+1 decomposition of  $\underline{\underline{J}}$  given in Eq. (1.3.21). One spatial dimension, and densities and orientations in that dimension, has been suppressed.

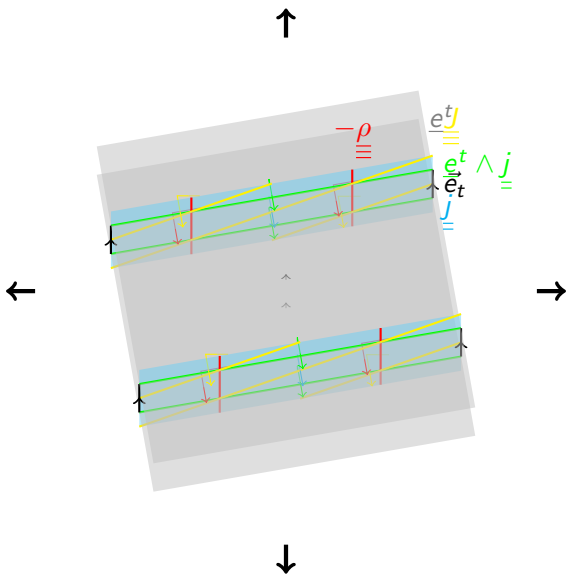

Figure 1.3.3 : An illustration of the 3+1 decomposition of  $\underline{\underline{J}}$  given in Eq. (1.3.21). One spatial dimension, and densities and orientations in that dimension, has been suppressed.

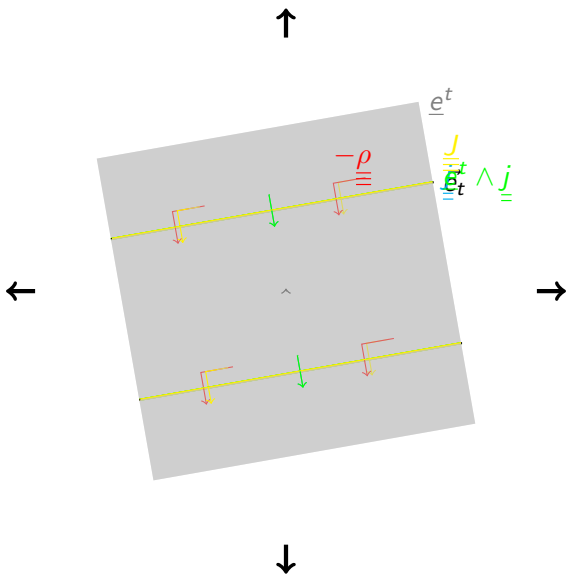

Figure 1.3.3 : An illustration of the 3+1 decomposition of  $\underline{J}$  given in Eq. (1.3.21). One spatial dimension, and densities and orientations in that dimension, has been suppressed.

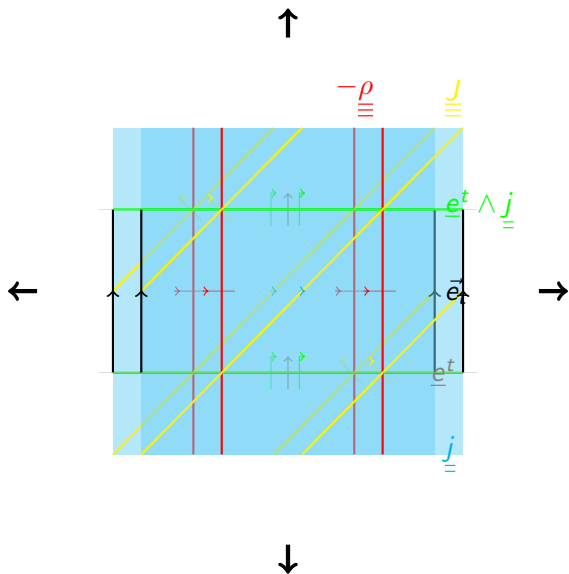

Figure 1.3.3 : An illustration of the 3+1 decomposition of  $\underline{\underline{J}}$  given in Eq. (1.3.21). One spatial dimension, and densities and orientations in that dimension, has been suppressed.

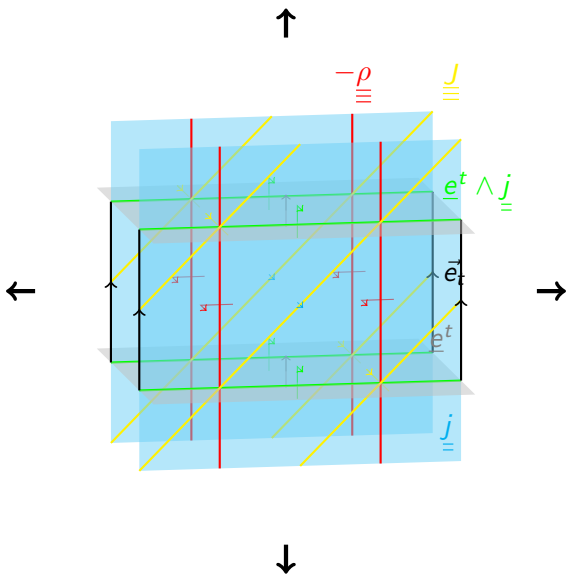

Figure 1.3.3 : An illustration of the 3+1 decomposition of  $\underline{\underline{J}}$  given in Eq. (1.3.21). One spatial dimension, and densities and orientations in that dimension, has been suppressed.





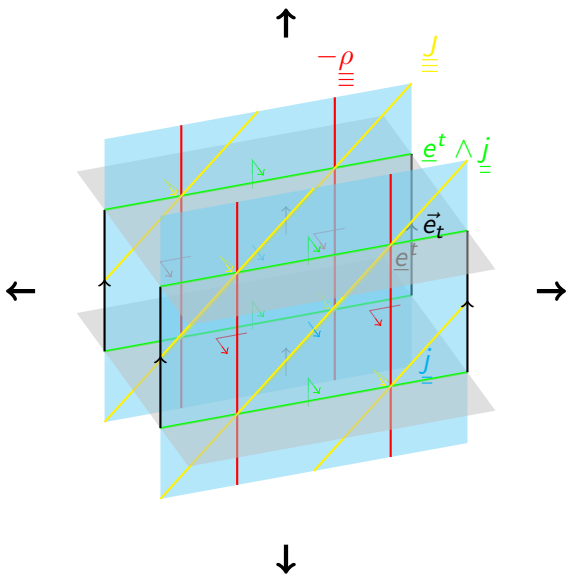

Figure 1.3.3 : An illustration of the 3+1 decomposition of  $\underline{\underline{J}}$  given in Eq. (1.3.21). One spatial dimension, and densities and orientations in that dimension, has been suppressed.

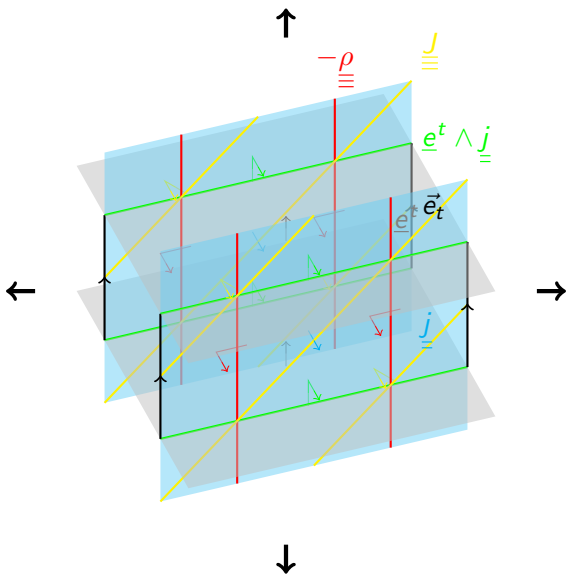

Figure 1.3.3 : An illustration of the 3+1 decomposition of  $\underline{\underline{J}}$  given in Eq. (1.3.21). One spatial dimension, and densities and orientations in that dimension, has been suppressed.

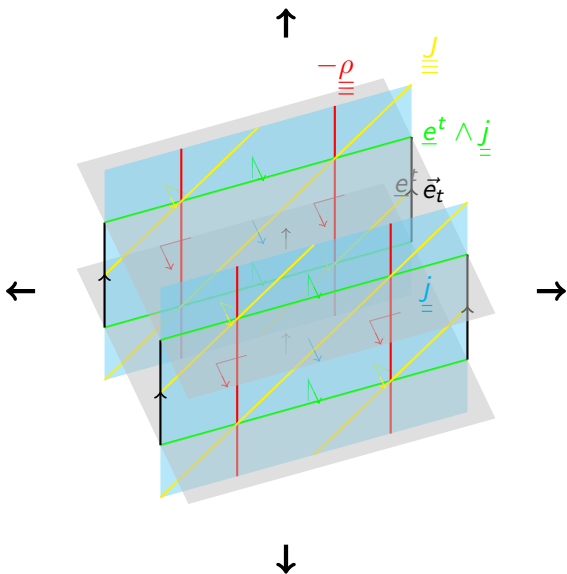

Figure 1.3.3 : An illustration of the 3+1 decomposition of  $\underline{\underline{J}}$  given in Eq. (1.3.21). One spatial dimension, and densities and orientations in that dimension, has been suppressed.

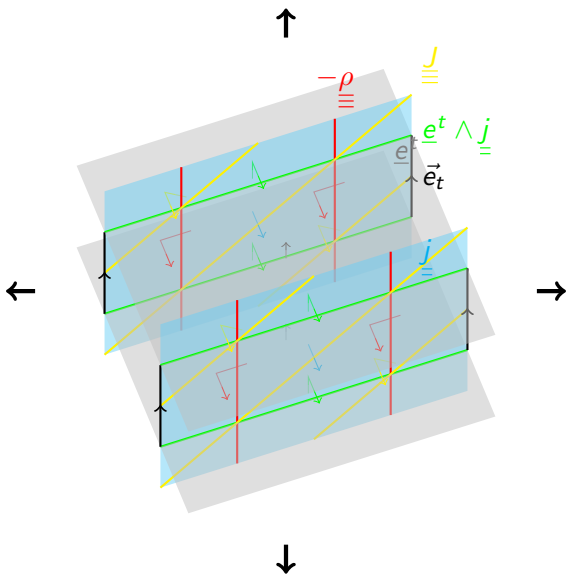

Figure 1.3.3 : An illustration of the 3+1 decomposition of  $\underline{J}$  given in Eq. (1.3.21). One spatial dimension, and densities and orientations in that dimension, has been suppressed.

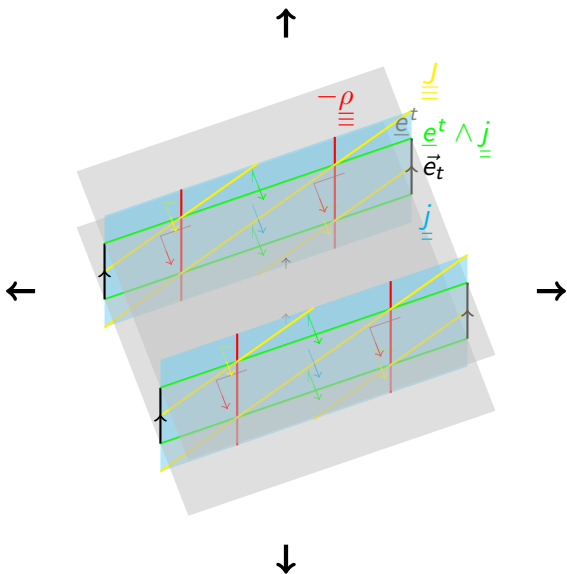

Figure 1.3.3 : An illustration of the 3+1 decomposition of  $\underline{\underline{J}}$  given in Eq. (1.3.21). One spatial dimension, and densities and orientations in that dimension, has been suppressed.

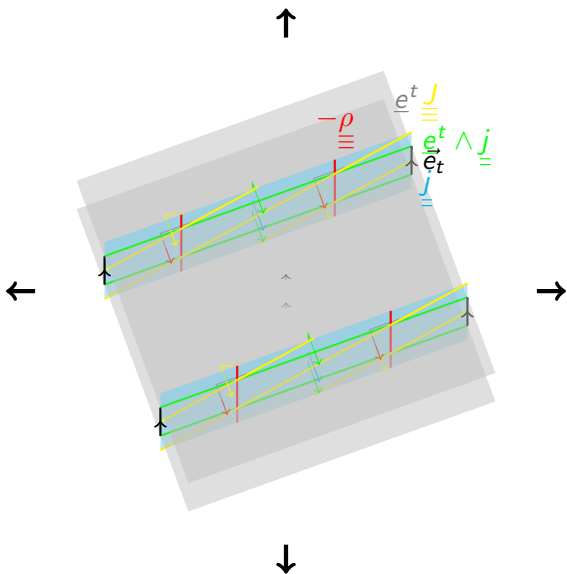

Figure 1.3.3 : An illustration of the 3+1 decomposition of  $\underline{\underline{J}}$  given in Eq. (1.3.21). One spatial dimension, and densities and orientations in that dimension, has been suppressed.

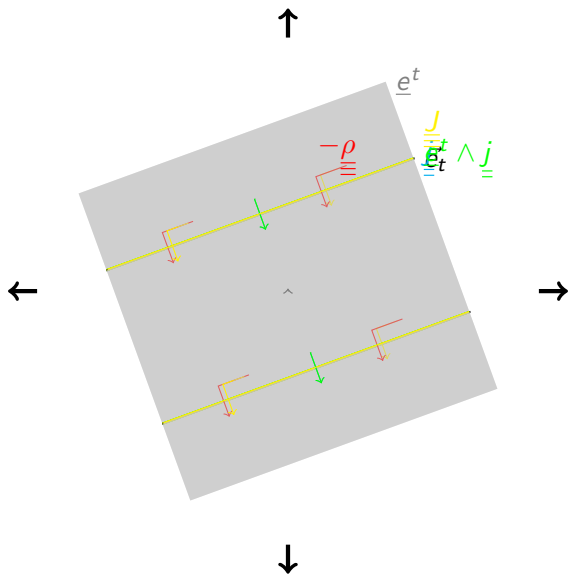

Figure 1.3.3 : An illustration of the 3+1 decomposition of  $\underline{\underline{J}}$  given in Eq. (1.3.21). One spatial dimension, and densities and orientations in that dimension, has been suppressed.

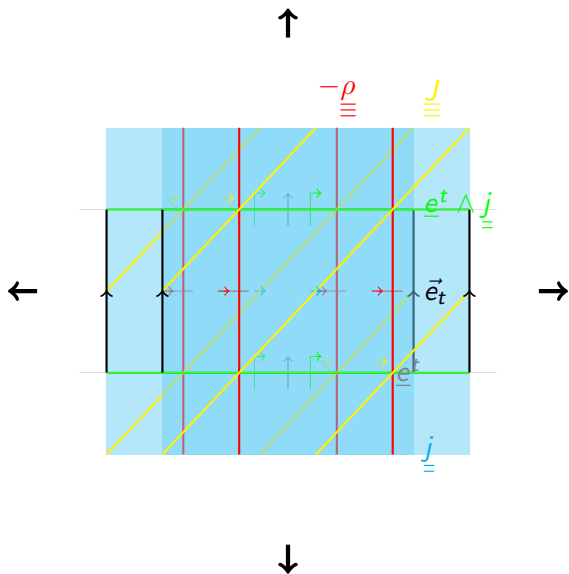

Figure 1.3.3 : An illustration of the 3+1 decomposition of  $\underline{\underline{J}}$  given in Eq. (1.3.21). One spatial dimension, and densities and orientations in that dimension, has been suppressed.



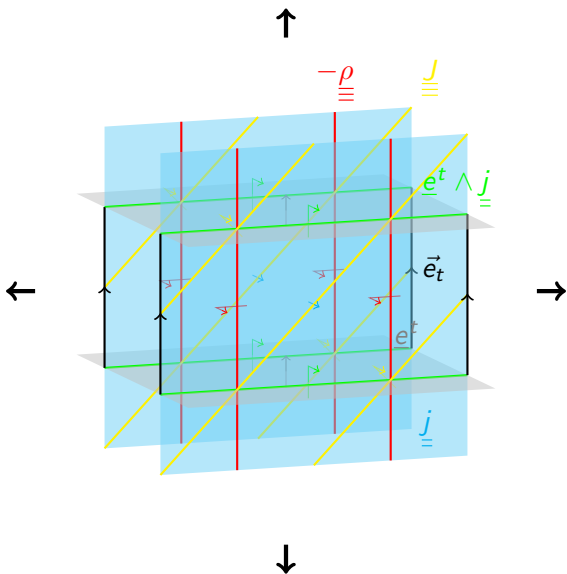

Figure 1.3.3 : An illustration of the 3+1 decomposition of  $\underline{\underline{J}}$  given in Eq. (1.3.21). One spatial dimension, and densities and orientations in that dimension, has been suppressed.

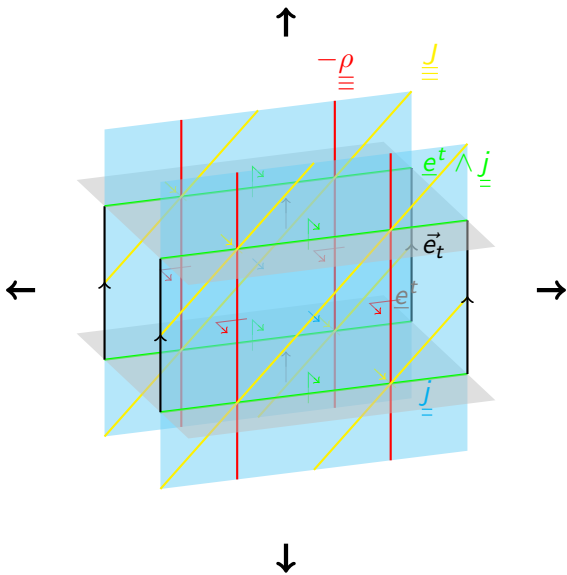

Figure 1.3.3 : An illustration of the 3+1 decomposition of  $\underline{\underline{J}}$  given in Eq. (1.3.21). One spatial dimension, and densities and orientations in that dimension, has been suppressed.

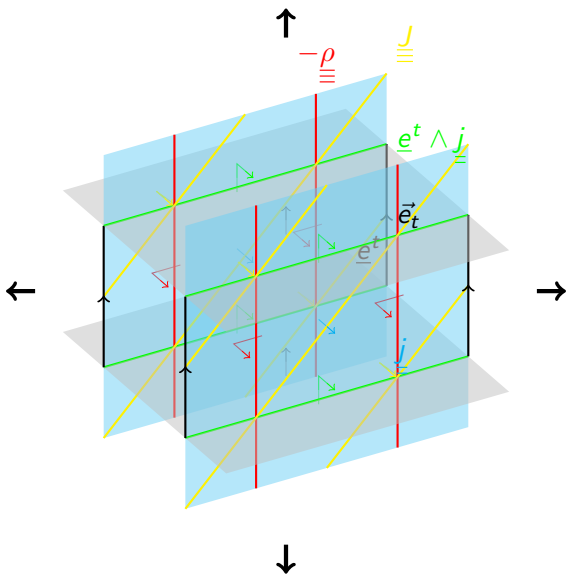

Figure 1.3.3 : An illustration of the 3+1 decomposition of  $\underline{\underline{J}}$  given in Eq. (1.3.21). One spatial dimension, and densities and orientations in that dimension, has been suppressed.

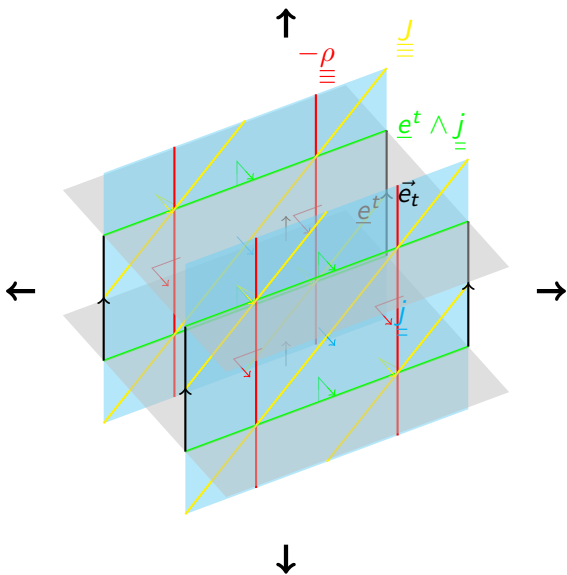

Figure 1.3.3 : An illustration of the 3+1 decomposition of  $\underline{J}$  given in Eq. (1.3.21). One spatial dimension, and densities and orientations in that dimension, has been suppressed.

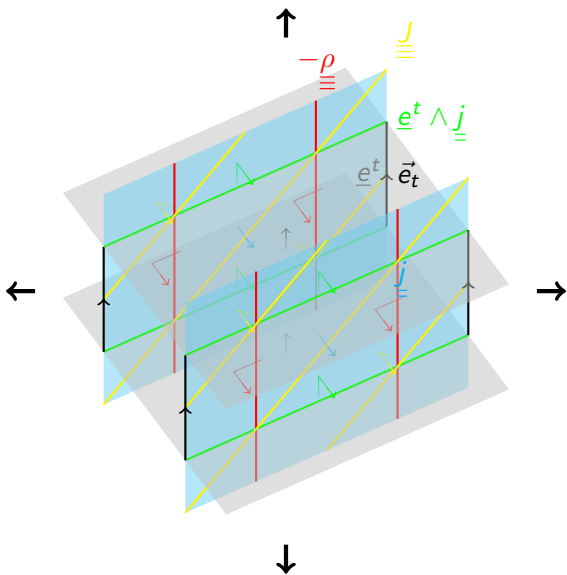

Figure 1.3.3 : An illustration of the 3+1 decomposition of  $\underline{\underline{J}}$  given in Eq. (1.3.21). One spatial dimension, and densities and orientations in that dimension, has been suppressed.

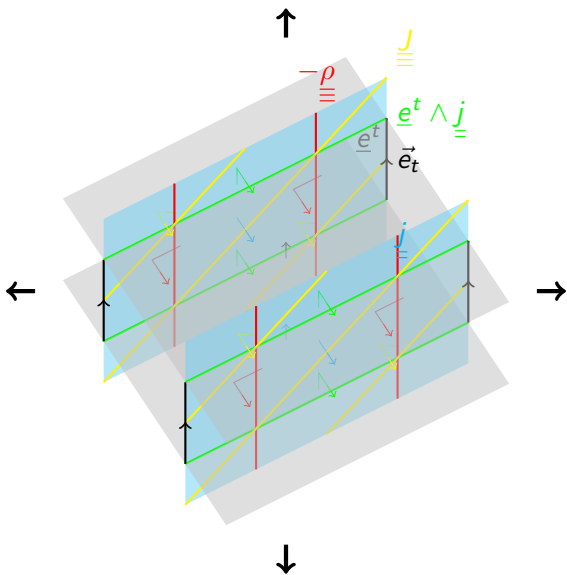

Figure 1.3.3 : An illustration of the 3+1 decomposition of  $\underline{J}$  given in Eq. (1.3.21). One spatial dimension, and densities and orientations in that dimension, has been suppressed.

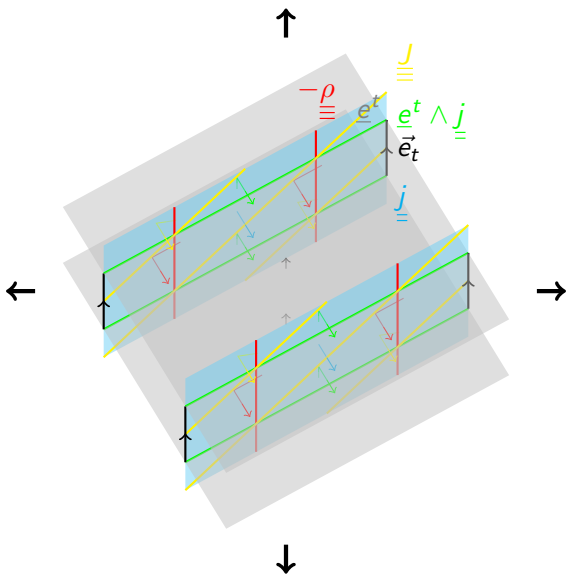

Figure 1.3.3 : An illustration of the 3+1 decomposition of  $\underline{\underline{J}}$  given in Eq. (1.3.21). One spatial dimension, and densities and orientations in that dimension, has been suppressed.

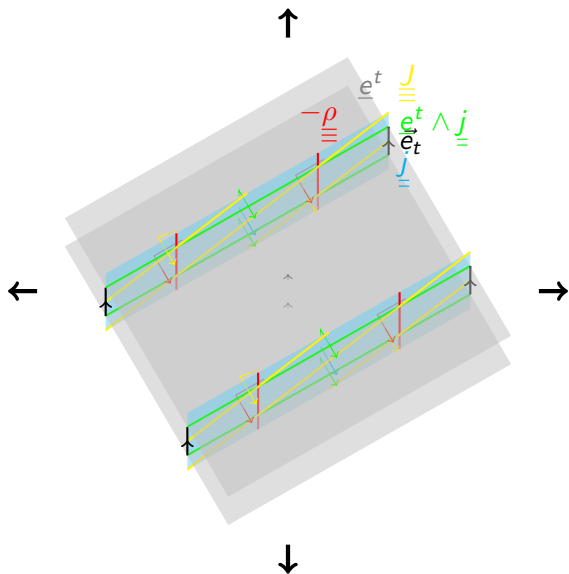

Figure 1.3.3 : An illustration of the 3+1 decomposition of  $\underline{J}$  given in Eq. (1.3.21). One spatial dimension, and densities and orientations in that dimension, has been suppressed.



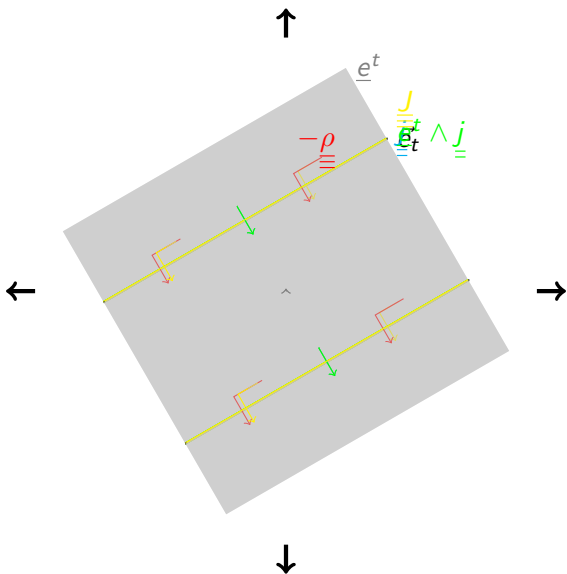

Figure 1.3.3 : An illustration of the 3+1 decomposition of  $\underline{\underline{J}}$  given in Eq. (1.3.21). One spatial dimension, and densities and orientations in that dimension, has been suppressed.

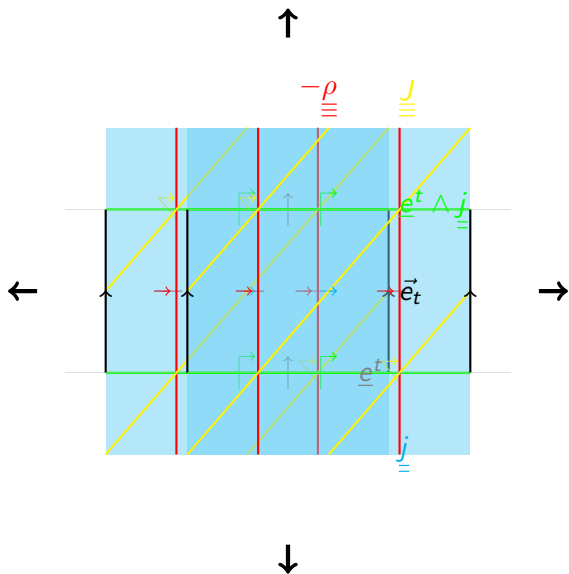

Figure 1.3.3 : An illustration of the 3+1 decomposition of  $\underline{J}$  given in Eq. (1.3.21). One spatial dimension, and densities and orientations in that dimension, has been suppressed.

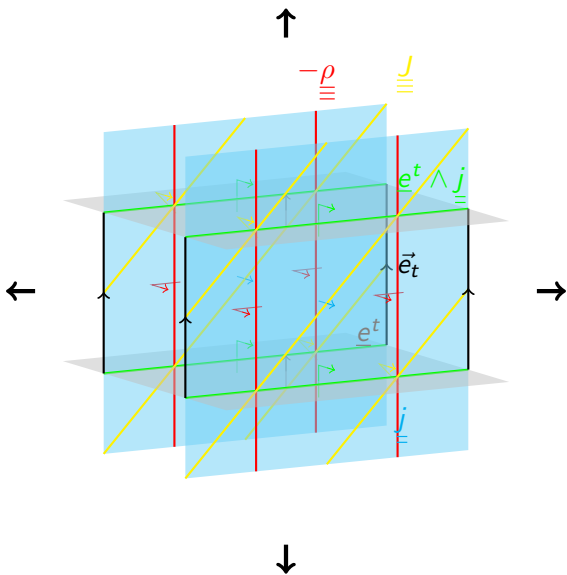

Figure 1.3.3 : An illustration of the 3+1 decomposition of  $\underline{\underline{J}}$  given in Eq. (1.3.21). One spatial dimension, and densities and orientations in that dimension, has been suppressed.

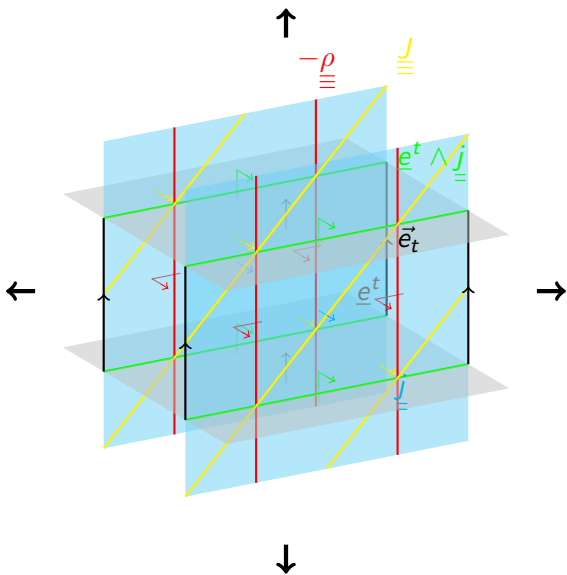

Figure 1.3.3 : An illustration of the 3+1 decomposition of  $\underline{J}$  given in Eq. (1.3.21). One spatial dimension, and densities and orientations in that dimension, has been suppressed.

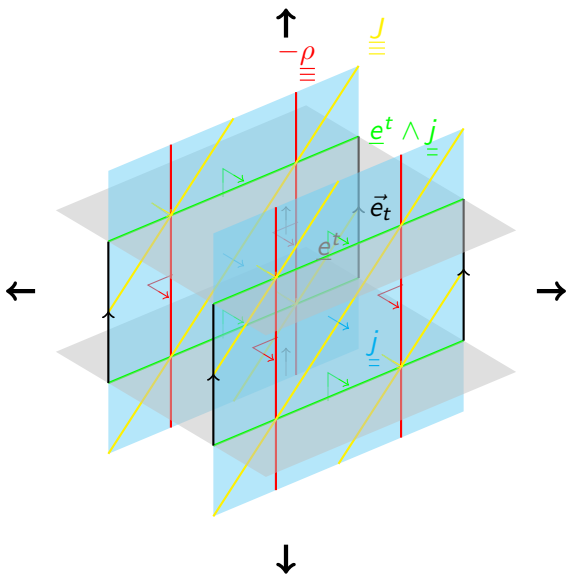

Figure 1.3.3 : An illustration of the 3+1 decomposition of  $\underline{J}$  given in Eq. (1.3.21). One spatial dimension, and densities and orientations in that dimension, has been suppressed.

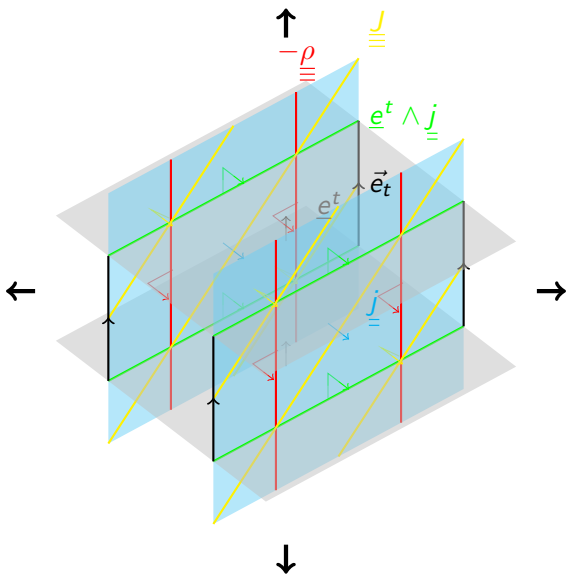

Figure 1.3.3 : An illustration of the 3+1 decomposition of  $\underline{\underline{J}}$  given in Eq. (1.3.21). One spatial dimension, and densities and orientations in that dimension, has been suppressed.

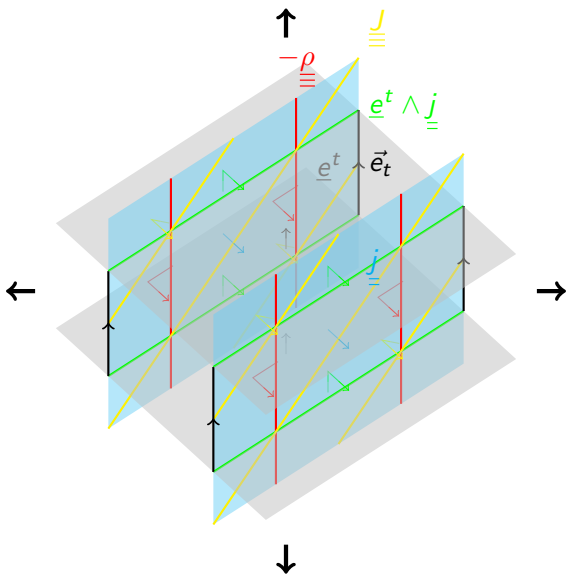

Figure 1.3.3 : An illustration of the 3+1 decomposition of  $\underline{J}$  given in Eq. (1.3.21). One spatial dimension, and densities and orientations in that dimension, has been suppressed.

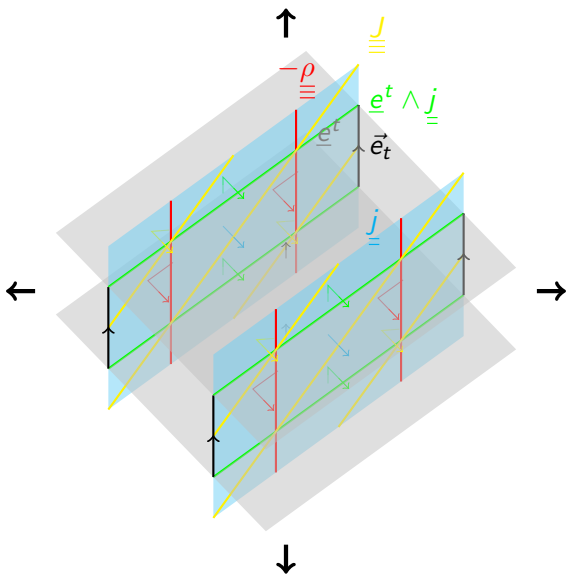

Figure 1.3.3 : An illustration of the 3+1 decomposition of  $\underline{J}$  given in Eq. (1.3.21). One spatial dimension, and densities and orientations in that dimension, has been suppressed.



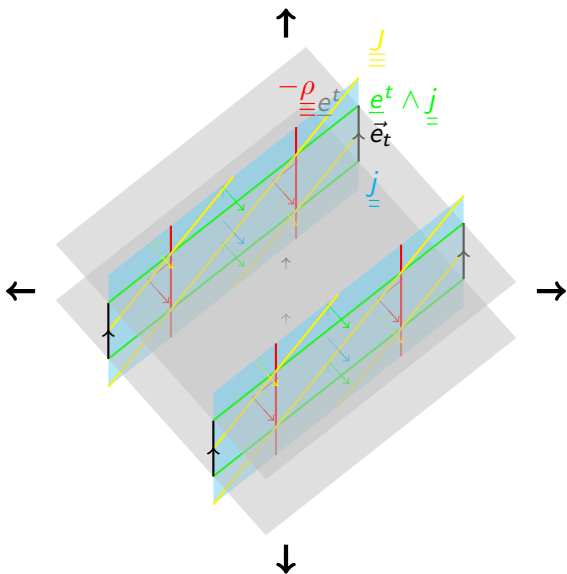

Figure 1.3.3 : An illustration of the 3+1 decomposition of  $\underline{\underline{J}}$  given in Eq. (1.3.21). One spatial dimension, and densities and orientations in that dimension, has been suppressed.

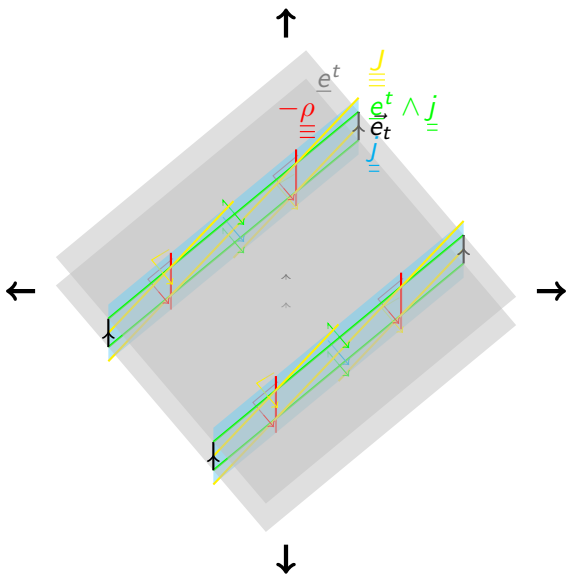

Figure 1.3.3 : An illustration of the 3+1 decomposition of  $\underline{\underline{J}}$  given in Eq. (1.3.21). One spatial dimension, and densities and orientations in that dimension, has been suppressed.

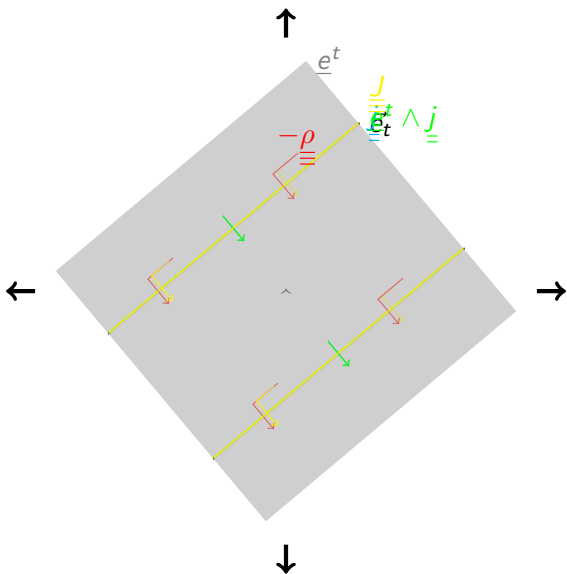

Figure 1.3.3 : An illustration of the 3+1 decomposition of  $\underline{\underline{J}}$  given in Eq. (1.3.21). One spatial dimension, and densities and orientations in that dimension, has been suppressed.

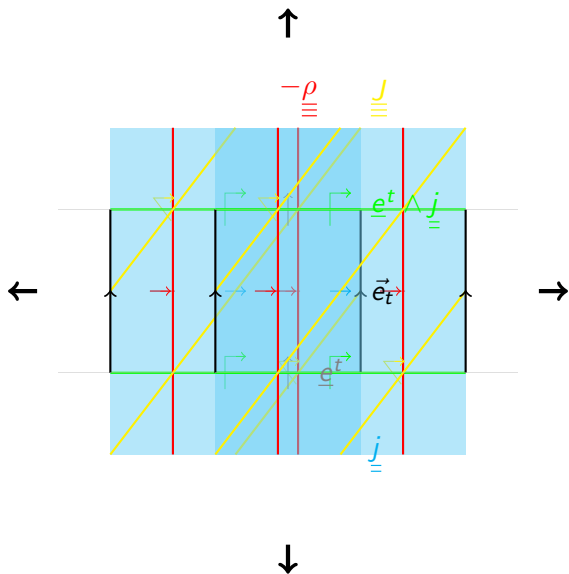

Figure 1.3.3 : An illustration of the 3+1 decomposition of  $\underline{\underline{J}}$  given in Eq. (1.3.21). One spatial dimension, and densities and orientations in that dimension, has been suppressed.

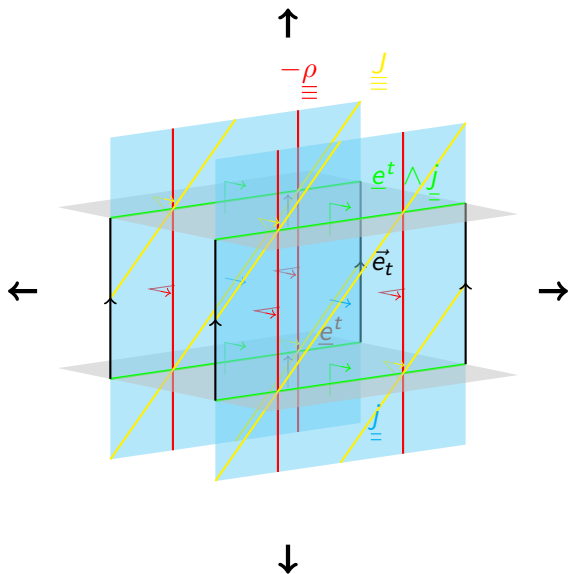

Figure 1.3.3 : An illustration of the 3+1 decomposition of  $\underline{J}$  given in Eq. (1.3.21). One spatial dimension, and densities and orientations in that dimension, has been suppressed.

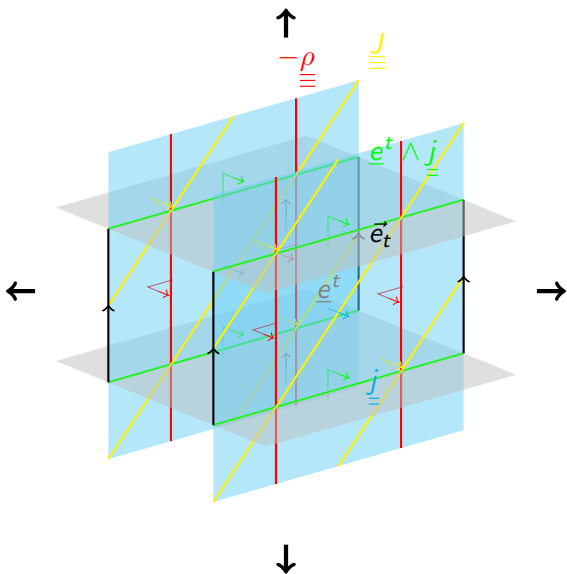

Figure 1.3.3 : An illustration of the 3+1 decomposition of  $\underline{J}$  given in Eq. (1.3.21). One spatial dimension, and densities and orientations in that dimension, has been suppressed.

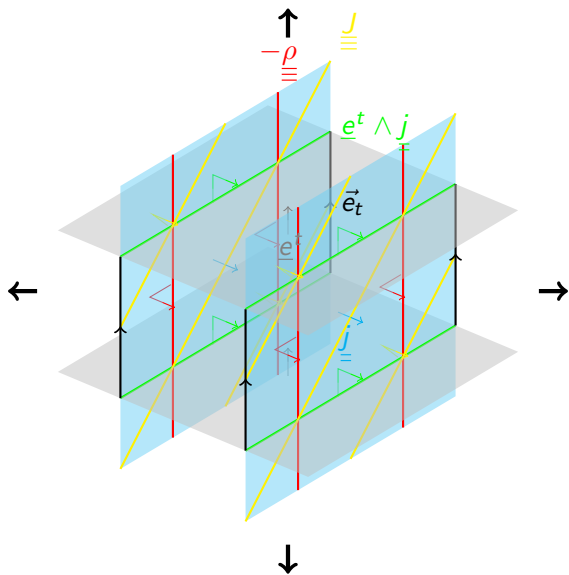

Figure 1.3.3 : An illustration of the 3+1 decomposition of  $\underline{J}$  given in Eq. (1.3.21). One spatial dimension, and densities and orientations in that dimension, has been suppressed.

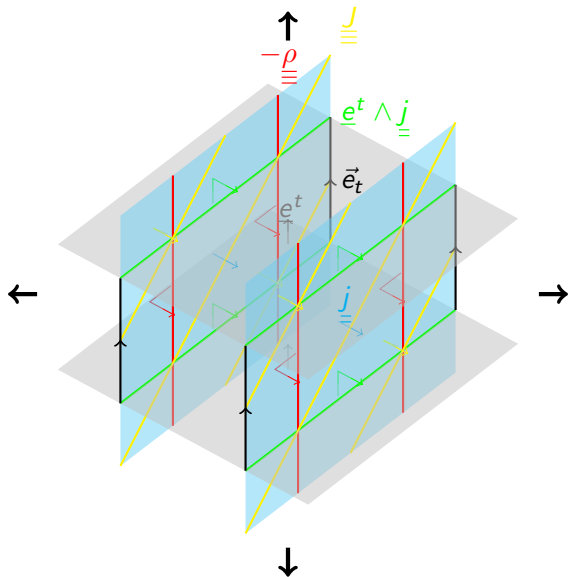

Figure 1.3.3 : An illustration of the 3+1 decomposition of  $\underline{J}$  given in Eq. (1.3.21). One spatial dimension, and densities and orientations in that dimension, has been suppressed.



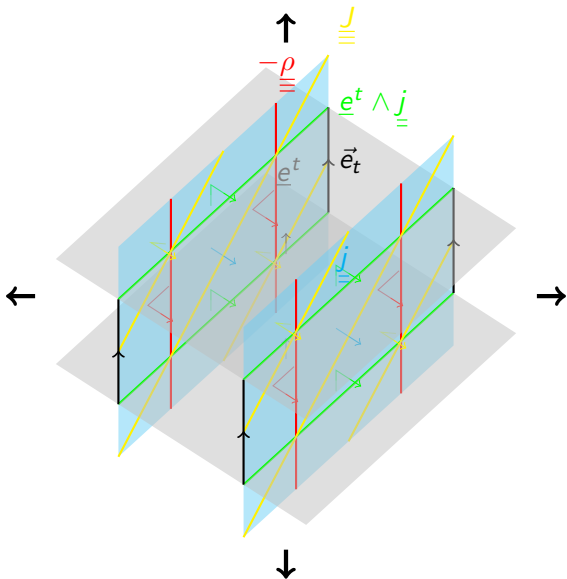

Figure 1.3.3 : An illustration of the 3+1 decomposition of  $\underline{\underline{J}}$  given in Eq. (1.3.21). One spatial dimension, and densities and orientations in that dimension, has been suppressed.

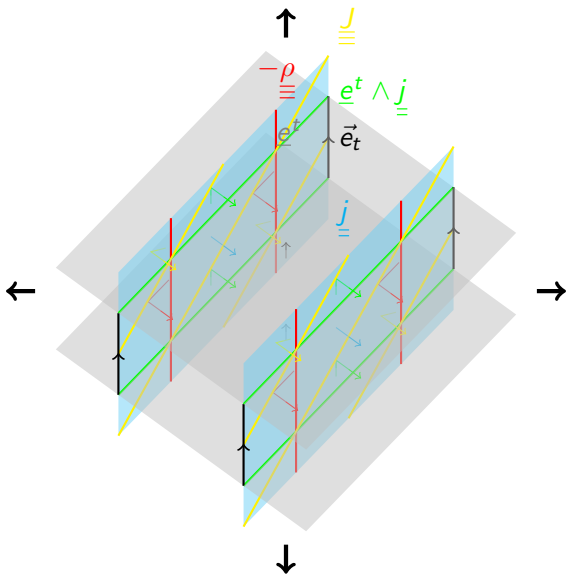

Figure 1.3.3 : An illustration of the 3+1 decomposition of  $\underline{J}$  given in Eq. (1.3.21). One spatial dimension, and densities and orientations in that dimension, has been suppressed.

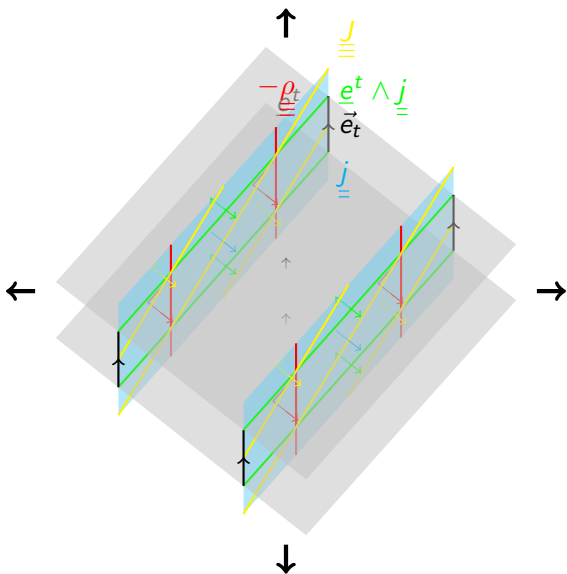

Figure 1.3.3 : An illustration of the 3+1 decomposition of  $\underline{\underline{J}}$  given in Eq. (1.3.21). One spatial dimension, and densities and orientations in that dimension, has been suppressed.

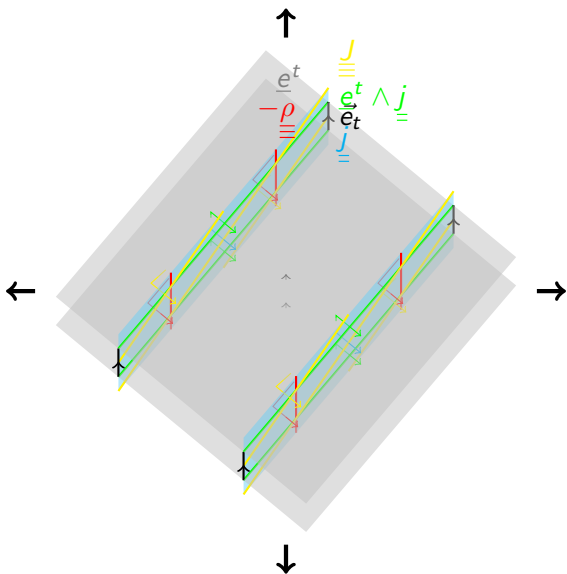

Figure 1.3.3 : An illustration of the 3+1 decomposition of  $\underline{J}$  given in Eq. (1.3.21). One spatial dimension, and densities and orientations in that dimension, has been suppressed.

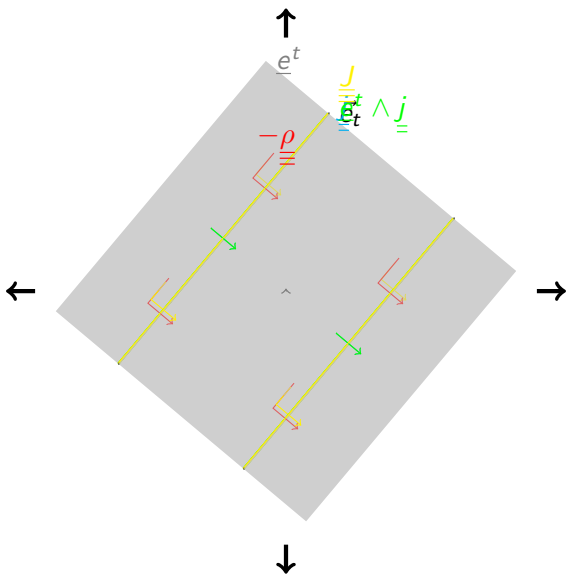

Figure 1.3.3 : An illustration of the 3+1 decomposition of  $\underline{\underline{J}}$  given in Eq. (1.3.21). One spatial dimension, and densities and orientations in that dimension, has been suppressed.

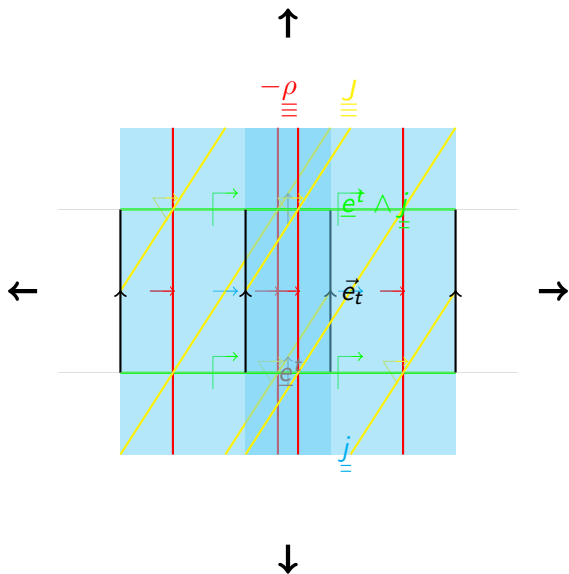

Figure 1.3.3 : An illustration of the 3+1 decomposition of  $\underline{J}$  given in Eq. (1.3.21). One spatial dimension, and densities and orientations in that dimension, has been suppressed.

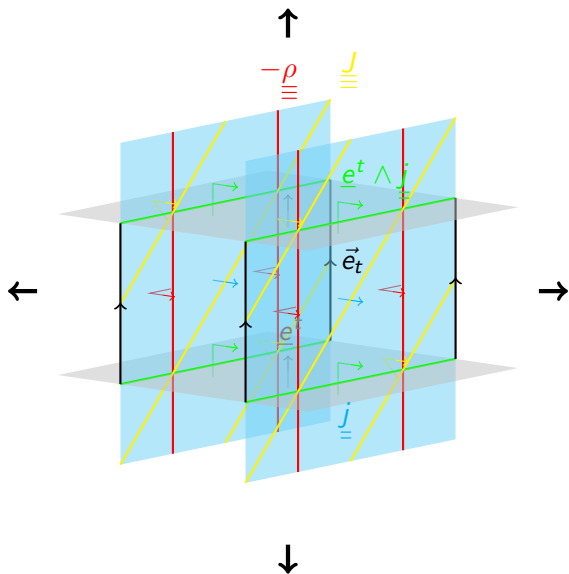

Figure 1.3.3 : An illustration of the 3+1 decomposition of  $\underline{J}$  given in Eq. (1.3.21). One spatial dimension, and densities and orientations in that dimension, has been suppressed.

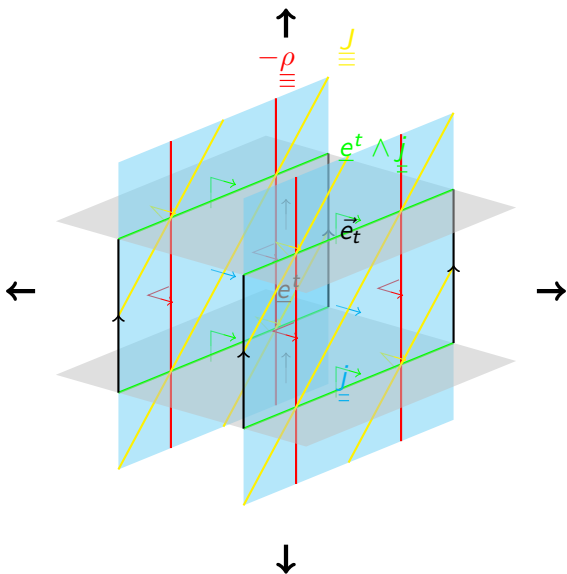

Figure 1.3.3 : An illustration of the 3+1 decomposition of  $\underline{\underline{J}}$  given in Eq. (1.3.21). One spatial dimension, and densities and orientations in that dimension, has been suppressed.



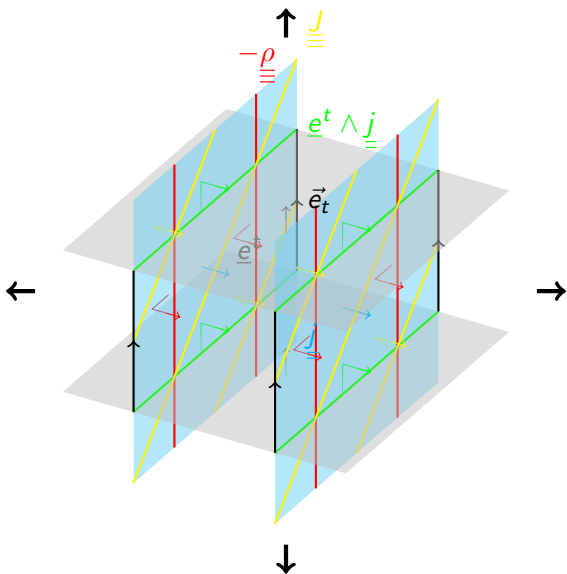

Figure 1.3.3 : An illustration of the 3+1 decomposition of  $\underline{\underline{J}}$  given in Eq. (1.3.21). One spatial dimension, and densities and orientations in that dimension, has been suppressed.

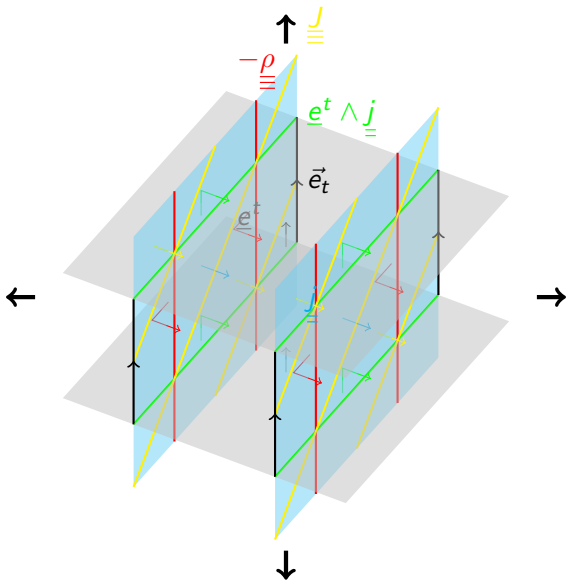

Figure 1.3.3 : An illustration of the 3+1 decomposition of  $\underline{\underline{J}}$  given in Eq. (1.3.21). One spatial dimension, and densities and orientations in that dimension, has been suppressed.

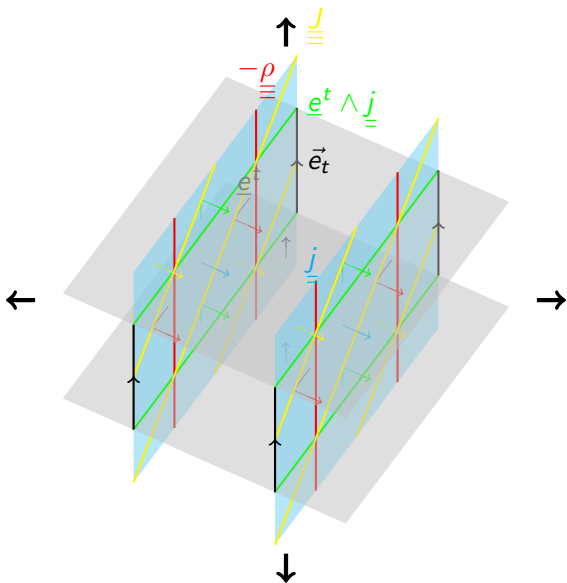

Figure 1.3.3 : An illustration of the 3+1 decomposition of  $\underline{\underline{J}}$  given in Eq. (1.3.21). One spatial dimension, and densities and orientations in that dimension, has been suppressed.

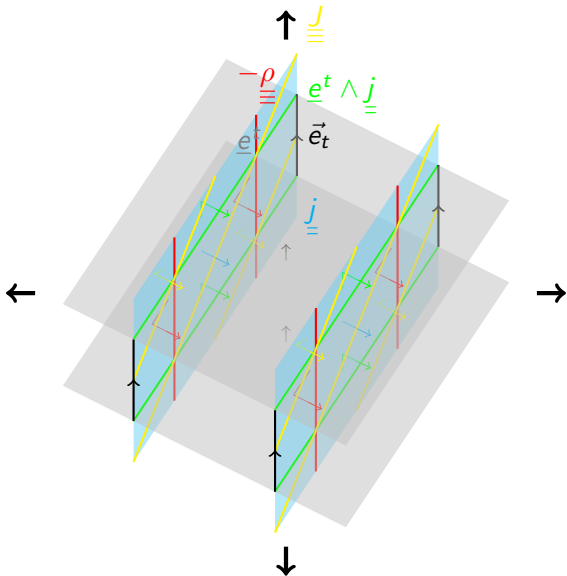

Figure 1.3.3 : An illustration of the 3+1 decomposition of  $\underline{J}$  given in Eq. (1.3.21). One spatial dimension, and densities and orientations in that dimension, has been suppressed.

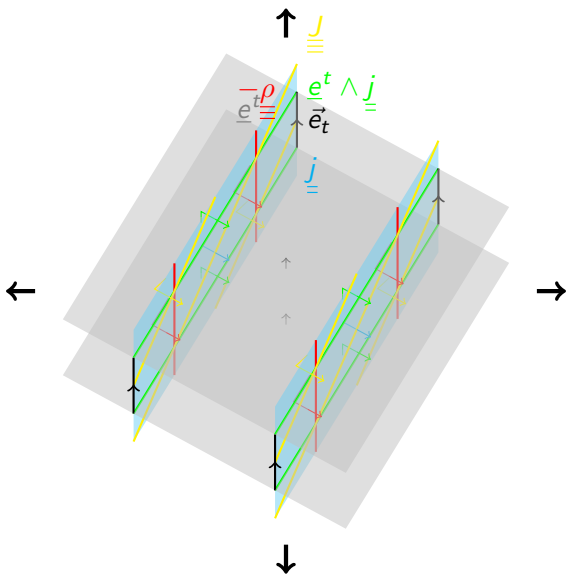

Figure 1.3.3 : An illustration of the 3+1 decomposition of  $\underline{\underline{J}}$  given in Eq. (1.3.21). One spatial dimension, and densities and orientations in that dimension, has been suppressed.

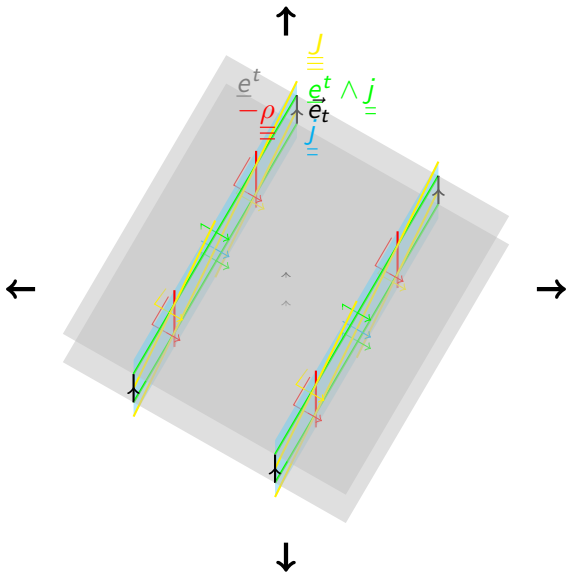

Figure 1.3.3 : An illustration of the 3+1 decomposition of  $\underline{\underline{J}}$  given in Eq. (1.3.21). One spatial dimension, and densities and orientations in that dimension, has been suppressed.

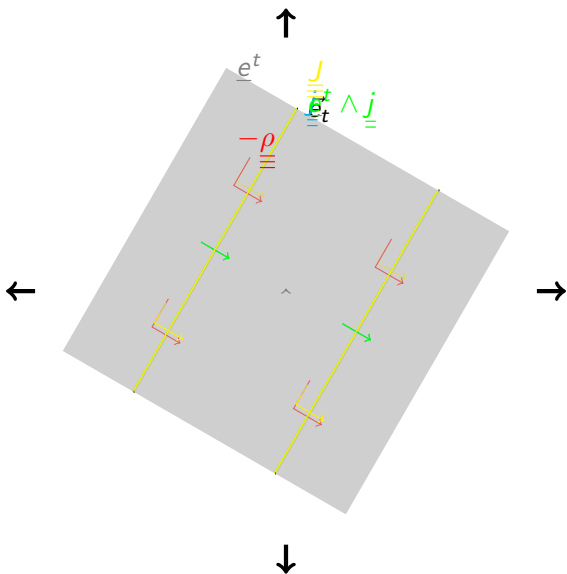

Figure 1.3.3 : An illustration of the 3+1 decomposition of  $\underline{\underline{J}}$  given in Eq. (1.3.21). One spatial dimension, and densities and orientations in that dimension, has been suppressed.

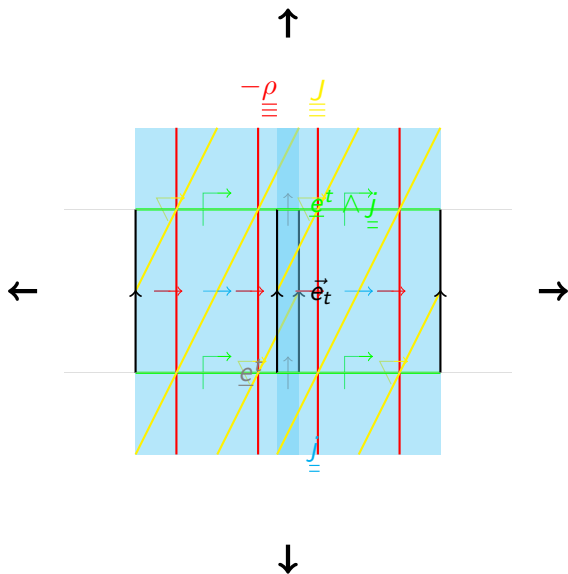

Figure 1.3.3 : An illustration of the 3+1 decomposition of  $\underline{J}$  given in Eq. (1.3.21). One spatial dimension, and densities and orientations in that dimension, has been suppressed.



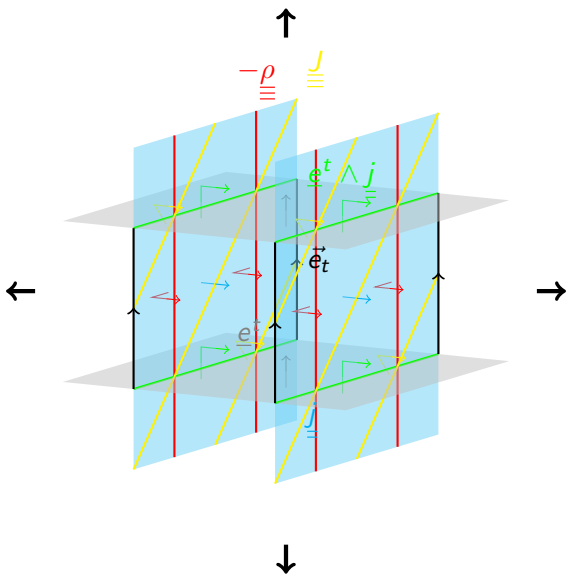

Figure 1.3.3 : An illustration of the 3+1 decomposition of  $\underline{\underline{J}}$  given in Eq. (1.3.21). One spatial dimension, and densities and orientations in that dimension, has been suppressed.

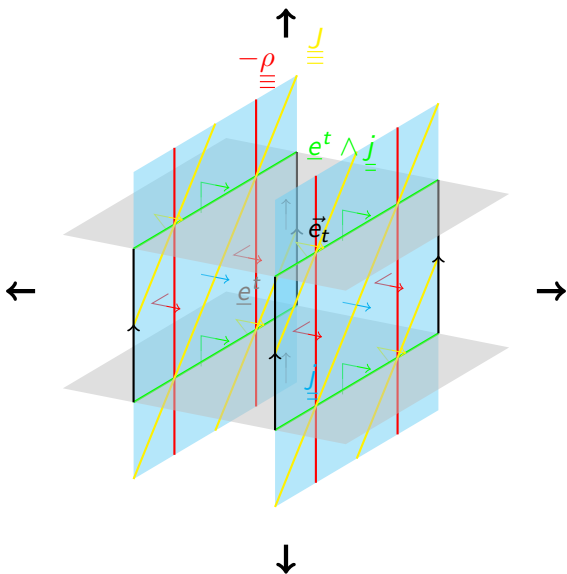

Figure 1.3.3 : An illustration of the 3+1 decomposition of  $\underline{J}$  given in Eq. (1.3.21). One spatial dimension, and densities and orientations in that dimension, has been suppressed.

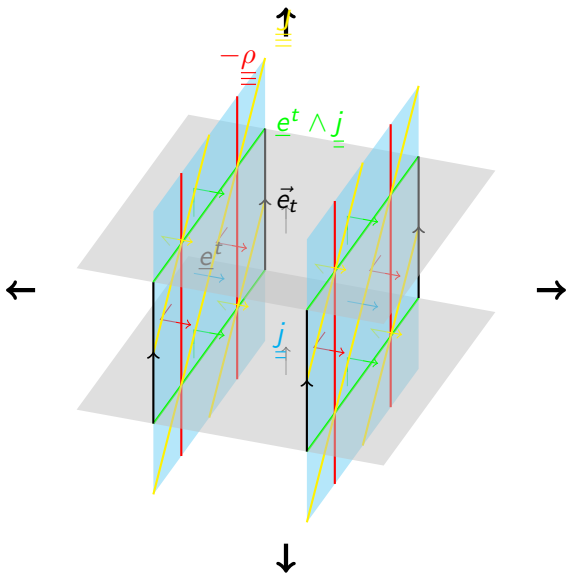

Figure 1.3.3 : An illustration of the 3+1 decomposition of  $\underline{\underline{J}}$  given in Eq. (1.3.21). One spatial dimension, and densities and orientations in that dimension, has been suppressed.

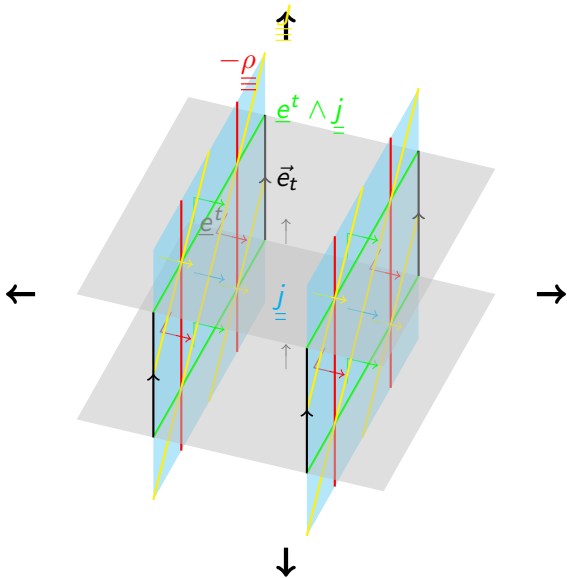

Figure 1.3.3 : An illustration of the 3+1 decomposition of  $\underline{J}$  given in Eq. (1.3.21). One spatial dimension, and densities and orientations in that dimension, has been suppressed.

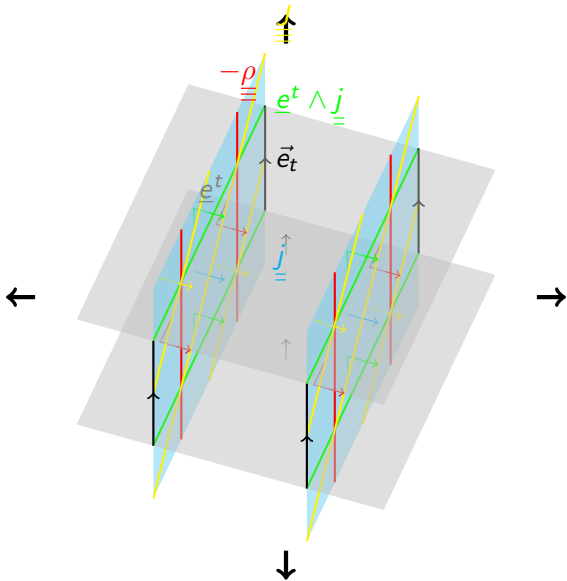

Figure 1.3.3 : An illustration of the 3+1 decomposition of  $\underline{\underline{J}}$  given in Eq. (1.3.21). One spatial dimension, and densities and orientations in that dimension, has been suppressed.

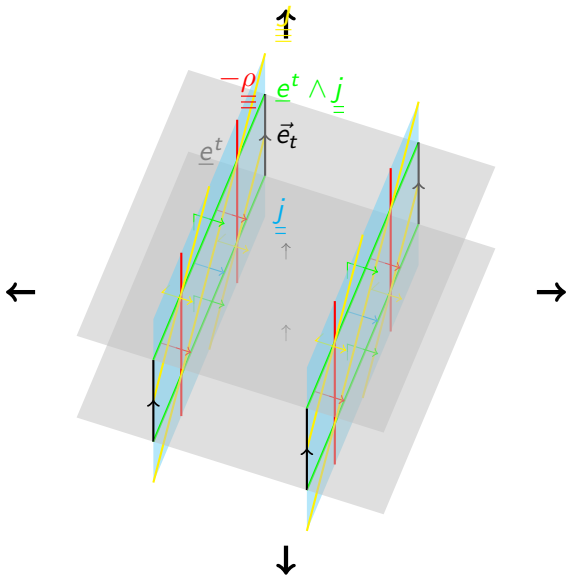

Figure 1.3.3 : An illustration of the 3+1 decomposition of  $\underline{J}$  given in Eq. (1.3.21). One spatial dimension, and densities and orientations in that dimension, has been suppressed.

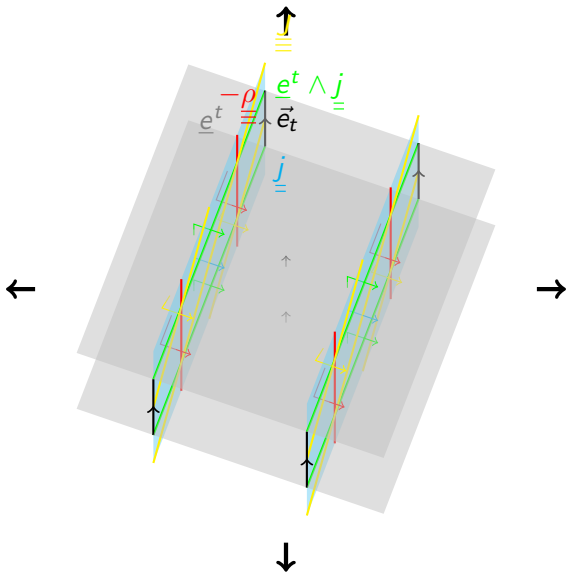

Figure 1.3.3 : An illustration of the 3+1 decomposition of  $\underline{J}$  given in Eq. (1.3.21). One spatial dimension, and densities and orientations in that dimension, has been suppressed.

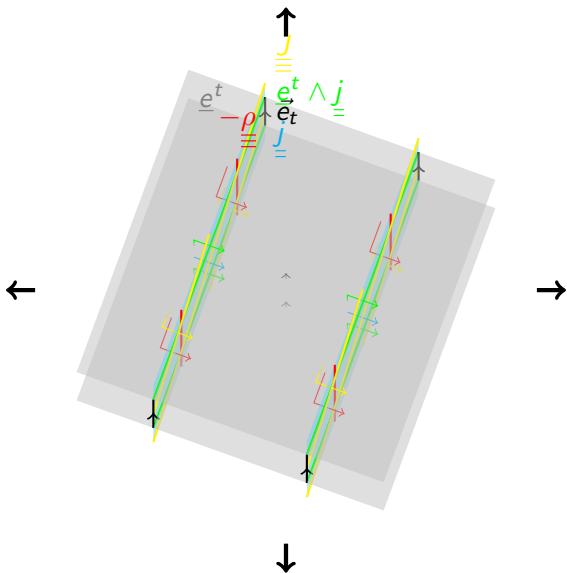

Figure 1.3.3 : An illustration of the 3+1 decomposition of  $\underline{\underline{J}}$  given in Eq. (1.3.21). One spatial dimension, and densities and orientations in that dimension, has been suppressed.



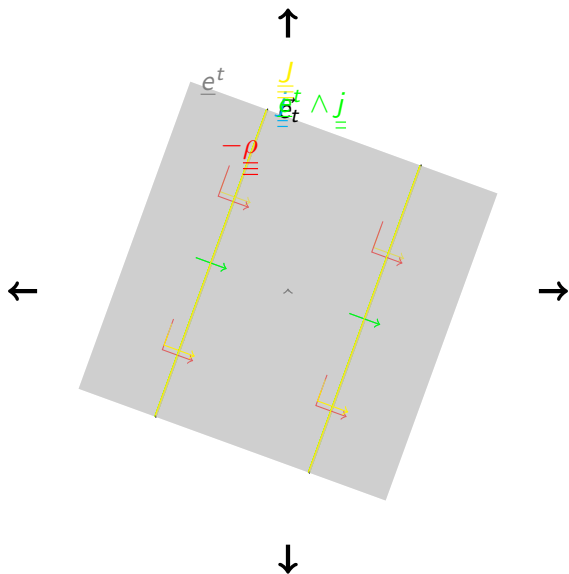

Figure 1.3.3 : An illustration of the 3+1 decomposition of  $\underline{J}$  given in Eq. (1.3.21). One spatial dimension, and densities and orientations in that dimension, has been suppressed.

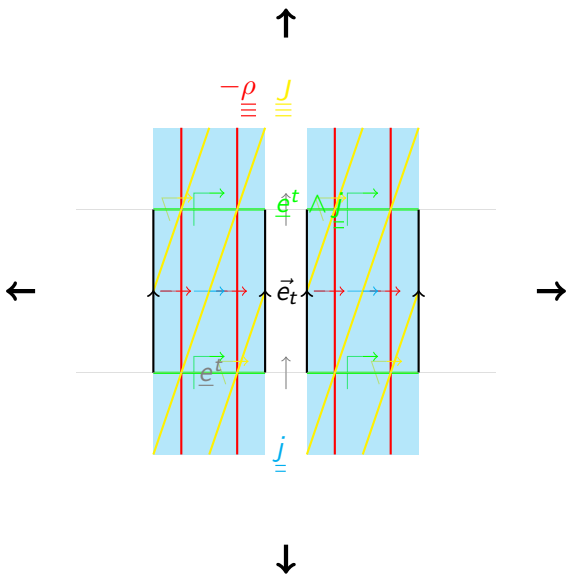

Figure 1.3.3 : An illustration of the 3+1 decomposition of  $\underline{\underline{J}}$  given in Eq. (1.3.21). One spatial dimension, and densities and orientations in that dimension, has been suppressed.

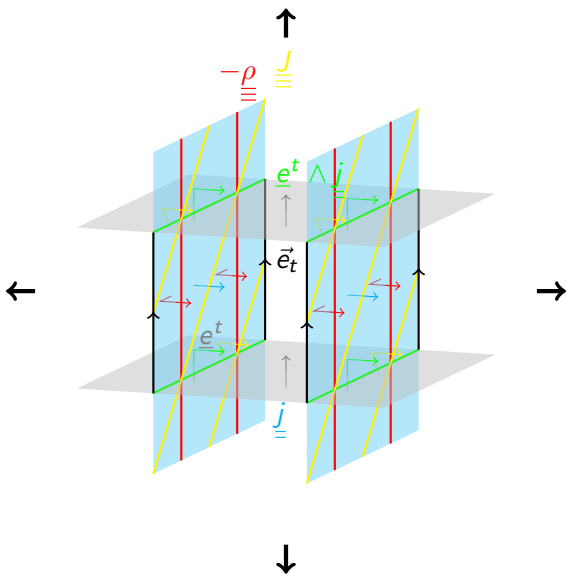

Figure 1.3.3 : An illustration of the 3+1 decomposition of  $\underline{J}$  given in Eq. (1.3.21). One spatial dimension, and densities and orientations in that dimension, has been suppressed.

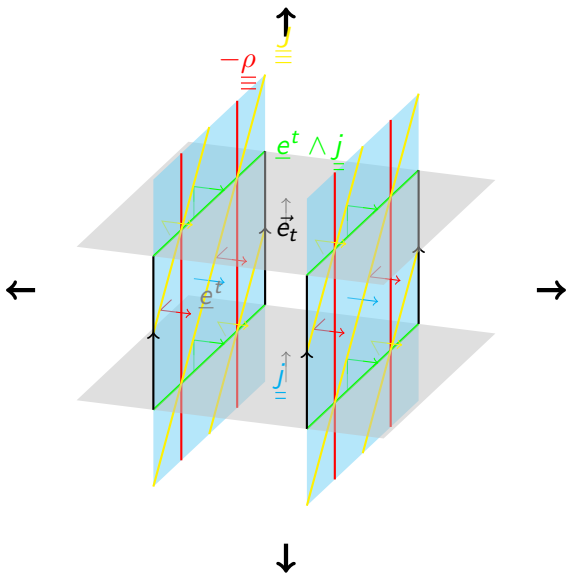

Figure 1.3.3 : An illustration of the 3+1 decomposition of  $\underline{\underline{J}}$  given in Eq. (1.3.21). One spatial dimension, and densities and orientations in that dimension, has been suppressed.

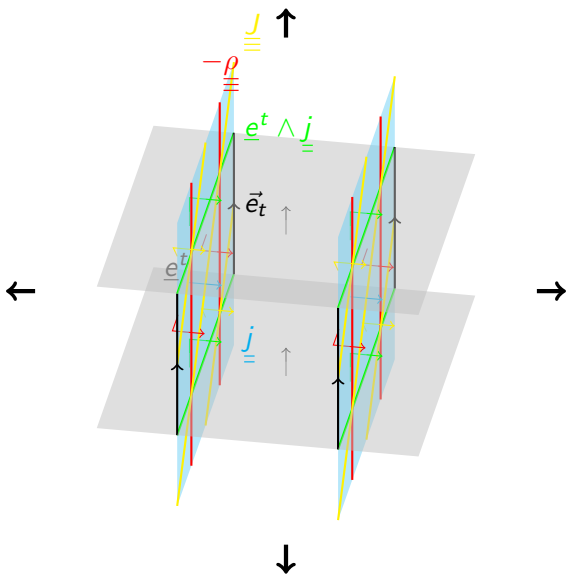

Figure 1.3.3 : An illustration of the 3+1 decomposition of  $\underline{J}$  given in Eq. (1.3.21). One spatial dimension, and densities and orientations in that dimension, has been suppressed.

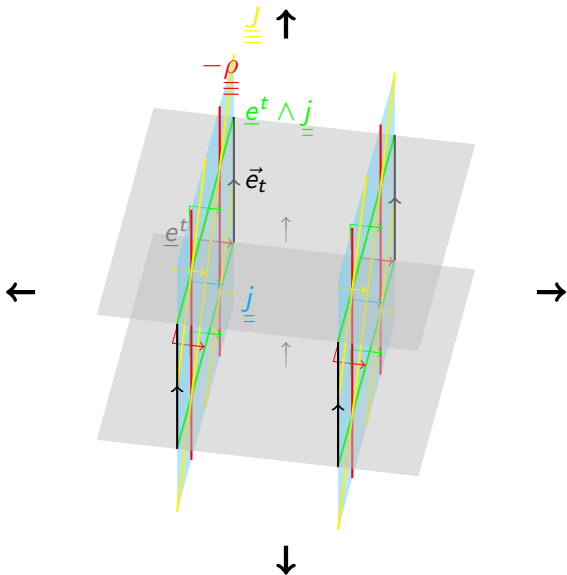

Figure 1.3.3 : An illustration of the 3+1 decomposition of  $\underline{J}$  given in Eq. (1.3.21). One spatial dimension, and densities and orientations in that dimension, has been suppressed.

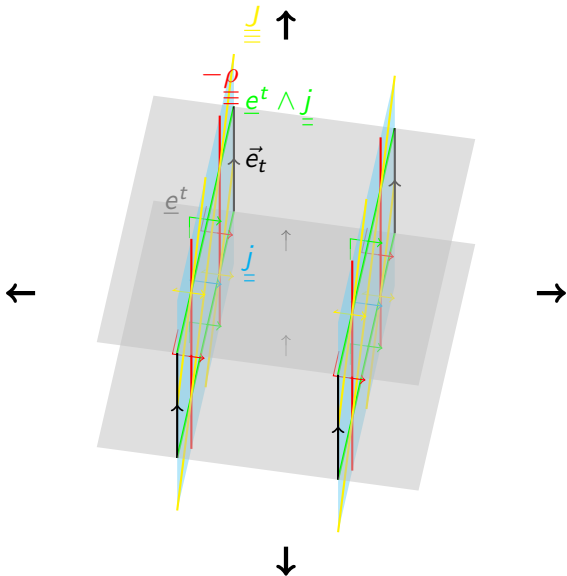

Figure 1.3.3 : An illustration of the 3+1 decomposition of  $\underline{J}$  given in Eq. (1.3.21). One spatial dimension, and densities and orientations in that dimension, has been suppressed.

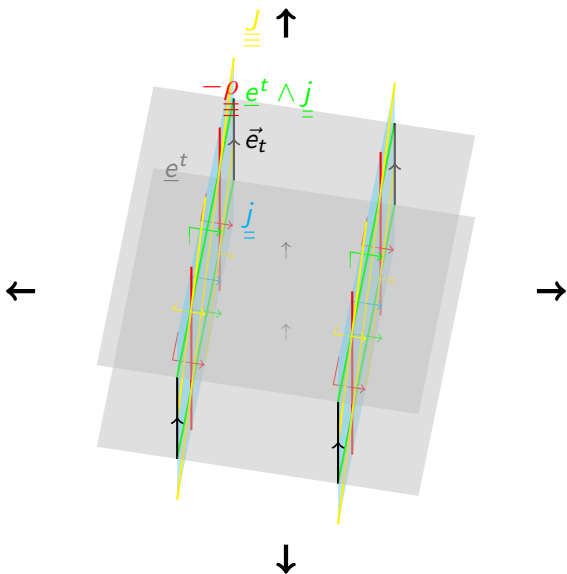

Figure 1.3.3 : An illustration of the 3+1 decomposition of  $\underline{J}$  given in Eq. (1.3.21). One spatial dimension, and densities and orientations in that dimension, has been suppressed.



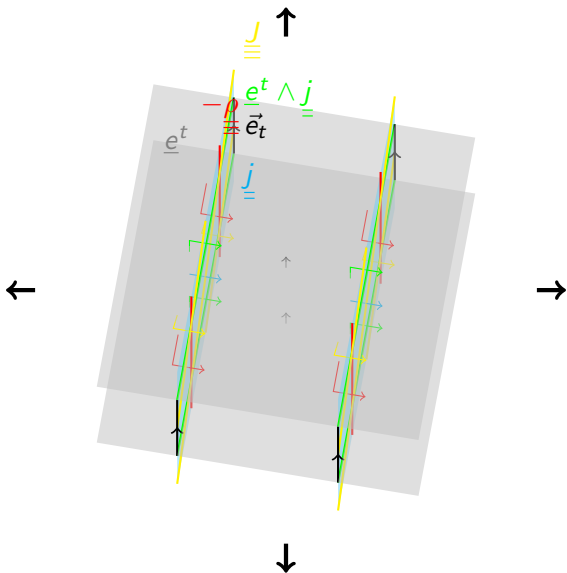

Figure 1.3.3 : An illustration of the 3+1 decomposition of  $\underline{\underline{J}}$  given in Eq. (1.3.21). One spatial dimension, and densities and orientations in that dimension, has been suppressed.

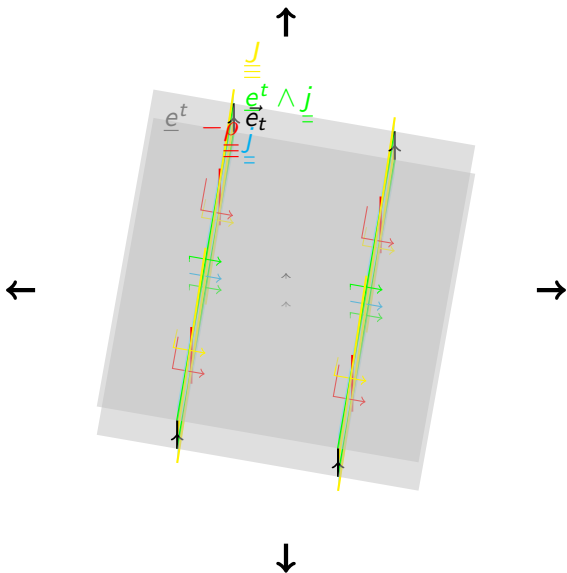

Figure 1.3.3 : An illustration of the 3+1 decomposition of  $\underline{\underline{J}}$  given in Eq. (1.3.21). One spatial dimension, and densities and orientations in that dimension, has been suppressed.

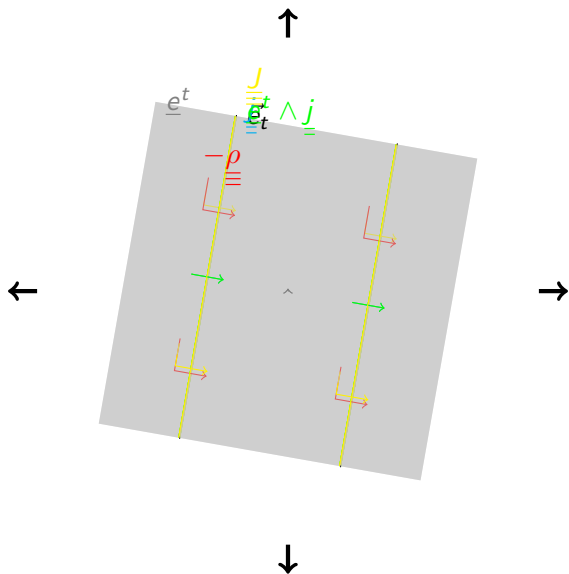

Figure 1.3.3 : An illustration of the 3+1 decomposition of  $\underline{J}$  given in Eq. (1.3.21). One spatial dimension, and densities and orientations in that dimension, has been suppressed.

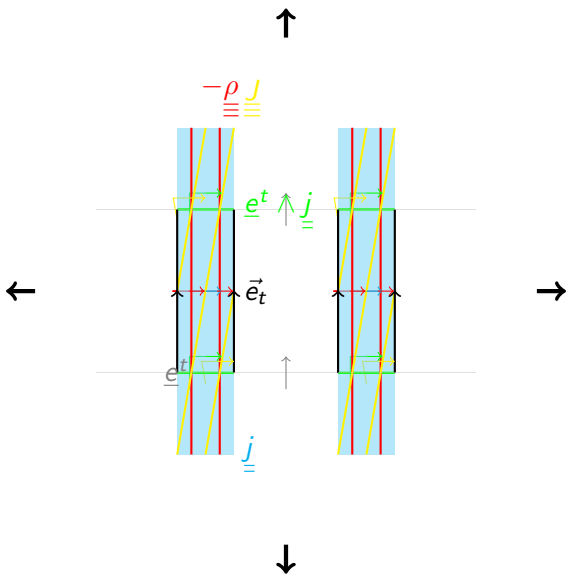

Figure 1.3.3 : An illustration of the 3+1 decomposition of  $\underline{\underline{J}}$  given in Eq. (1.3.21). One spatial dimension, and densities and orientations in that dimension, has been suppressed.

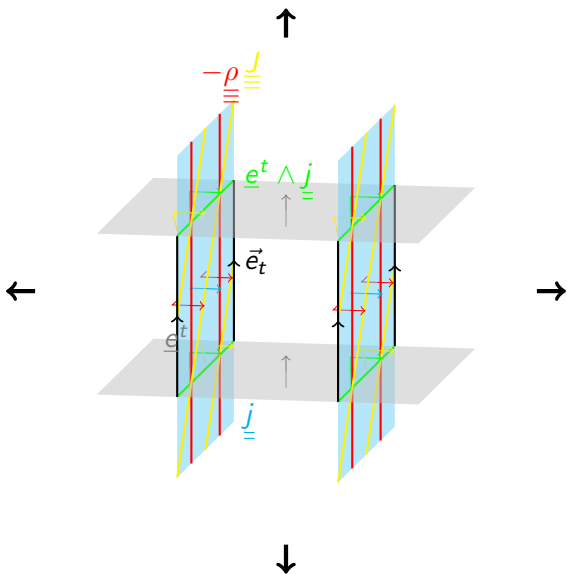

Figure 1.3.3 : An illustration of the 3+1 decomposition of  $\underline{J}$  given in Eq. (1.3.21). One spatial dimension, and densities and orientations in that dimension, has been suppressed.

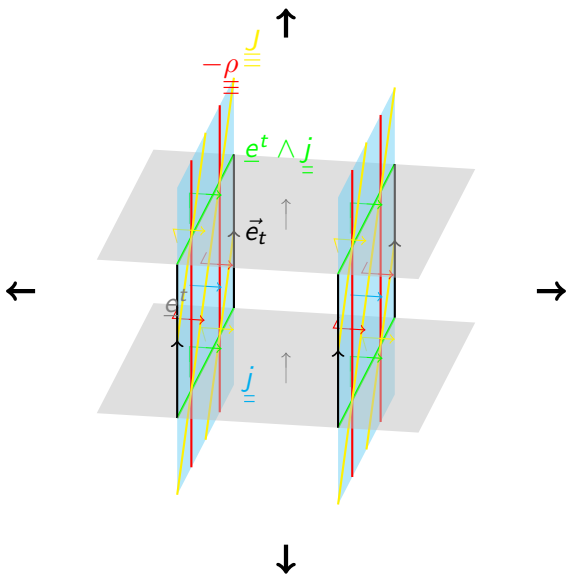

Figure 1.3.3 : An illustration of the 3+1 decomposition of  $\underline{\underline{J}}$  given in Eq. (1.3.21). One spatial dimension, and densities and orientations in that dimension, has been suppressed.

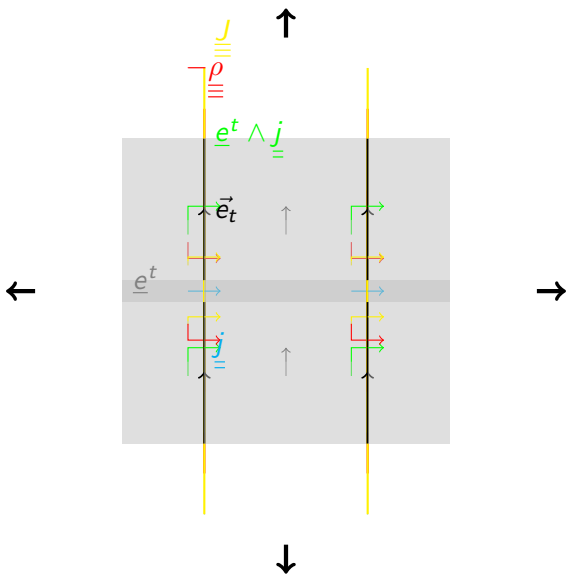

Figure 1.3.3 : An illustration of the 3+1 decomposition of  $\underline{J}$  given in Eq. (1.3.21). One spatial dimension, and densities and orientations in that dimension, has been suppressed.

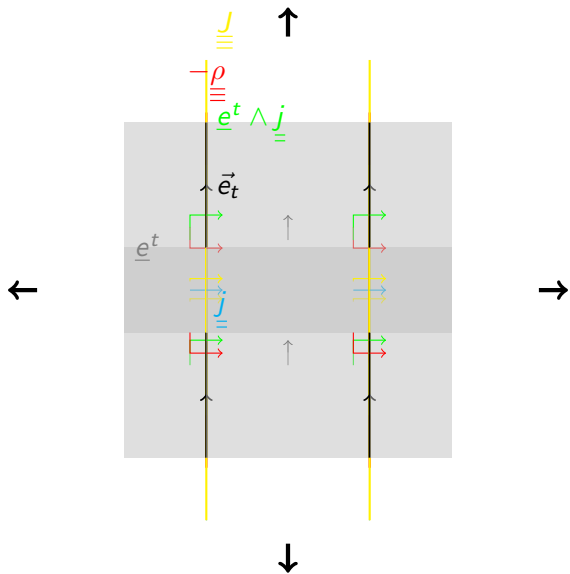

Figure 1.3.3 : An illustration of the 3+1 decomposition of  $\underline{J}$  given in Eq. (1.3.21). One spatial dimension, and densities and orientations in that dimension, has been suppressed.



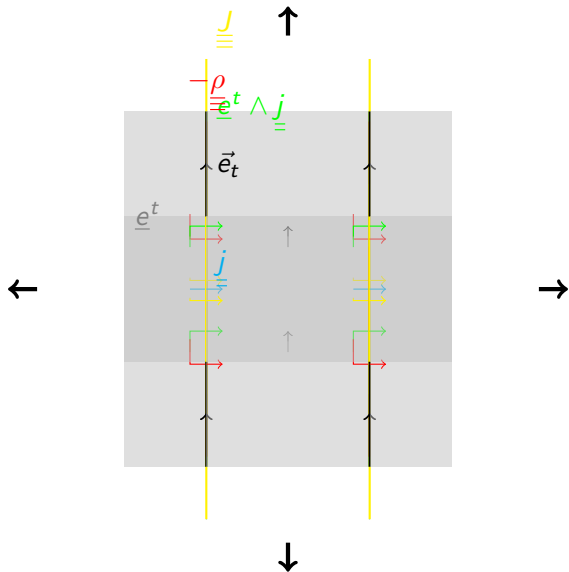

Figure 1.3.3 : An illustration of the 3+1 decomposition of  $\underline{J}$  given in Eq. (1.3.21). One spatial dimension, and densities and orientations in that dimension, has been suppressed.

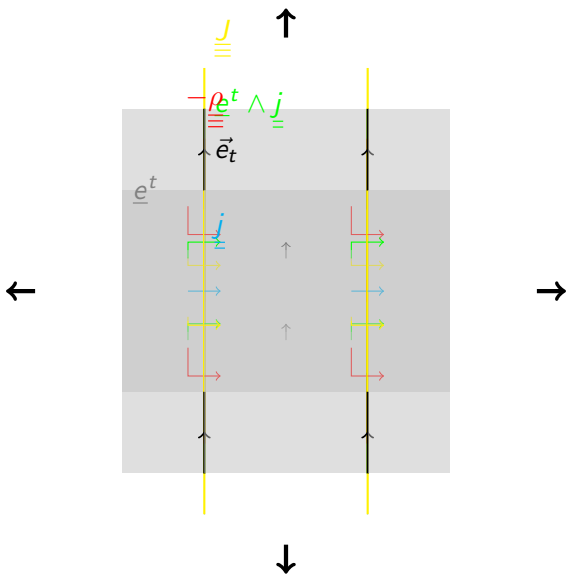

Figure 1.3.3 : An illustration of the 3+1 decomposition of  $\underline{\underline{J}}$  given in Eq. (1.3.21). One spatial dimension, and densities and orientations in that dimension, has been suppressed.

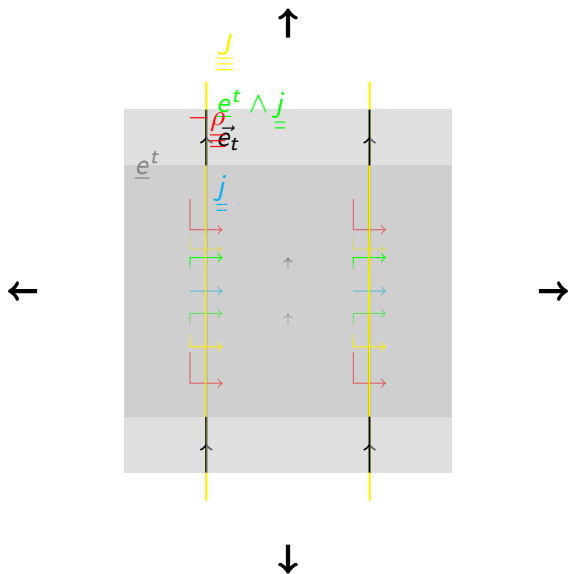

Figure 1.3.3 : An illustration of the 3+1 decomposition of  $\underline{\underline{J}}$  given in Eq. (1.3.21). One spatial dimension, and densities and orientations in that dimension, has been suppressed.

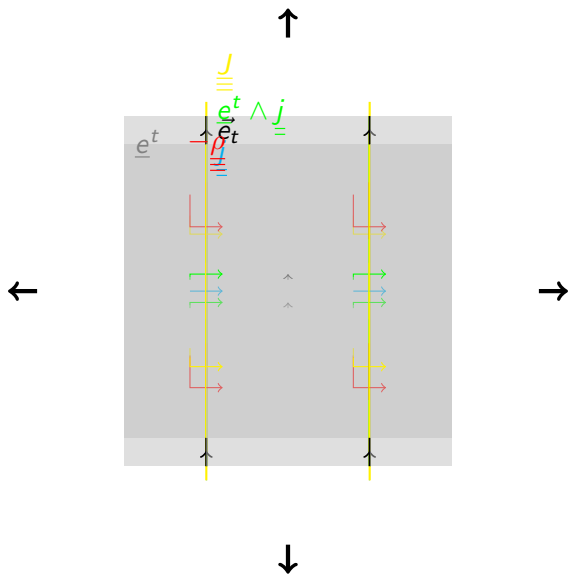

Figure 1.3.3 : An illustration of the 3+1 decomposition of  $\underline{\underline{J}}$  given in Eq. (1.3.21). One spatial dimension, and densities and orientations in that dimension, has been suppressed.

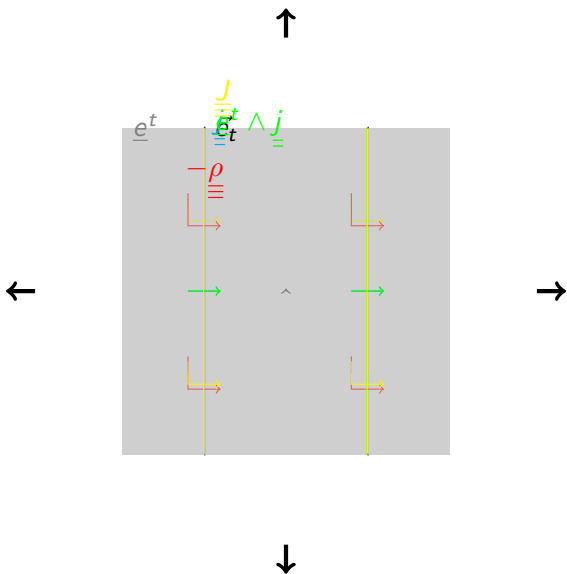

Figure 1.3.3 : An illustration of the 3+1 decomposition of  $\underline{J}$  given in Eq. (1.3.21). One spatial dimension, and densities and orientations in that dimension, has been suppressed.

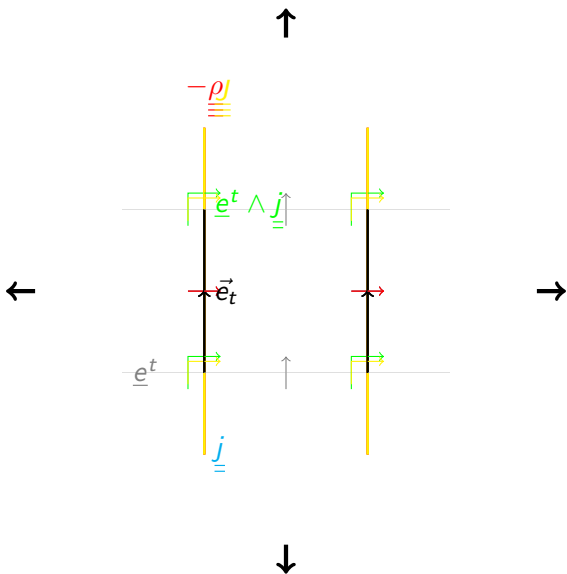

Figure 1.3.3 : An illustration of the 3+1 decomposition of  $\underline{J}$  given in Eq. (1.3.21). One spatial dimension, and densities and orientations in that dimension, has been suppressed.

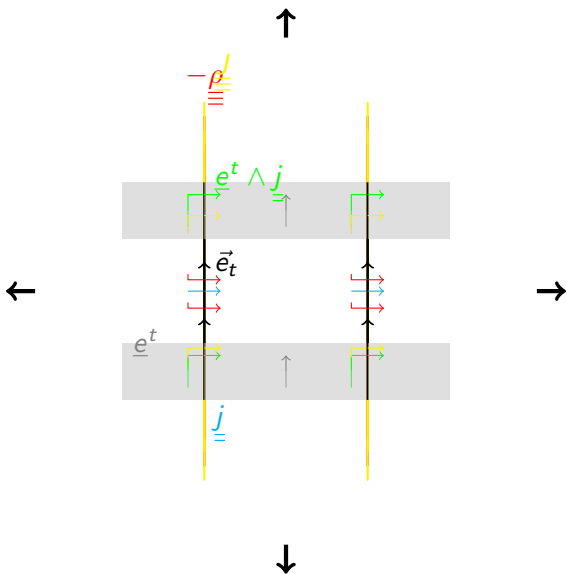

Figure 1.3.3 : An illustration of the 3+1 decomposition of  $\underline{J}$  given in Eq. (1.3.21). One spatial dimension, and densities and orientations in that dimension, has been suppressed.

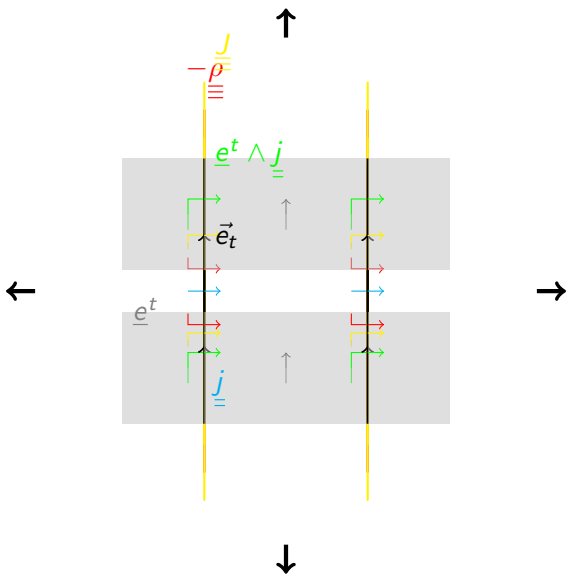

Figure 1.3.3 : An illustration of the 3+1 decomposition of  $\underline{J}$  given in Eq. (1.3.21). One spatial dimension, and densities and orientations in that dimension, has been suppressed.



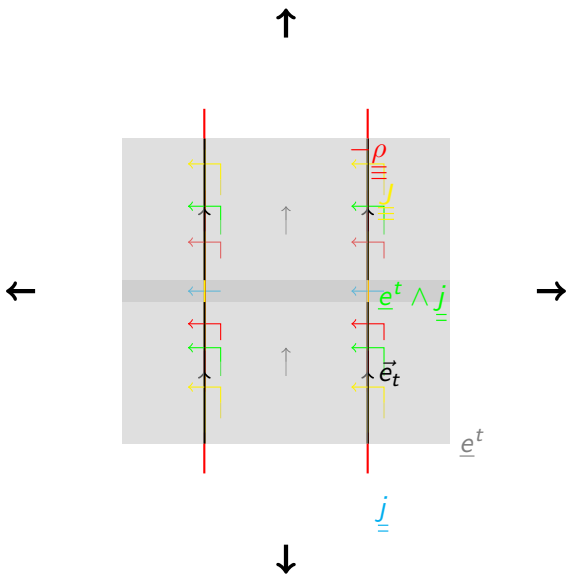

Figure 1.3.3 : An illustration of the 3+1 decomposition of  $\underline{J}$  given in Eq. (1.3.21). One spatial dimension, and densities and orientations in that dimension, has been suppressed.

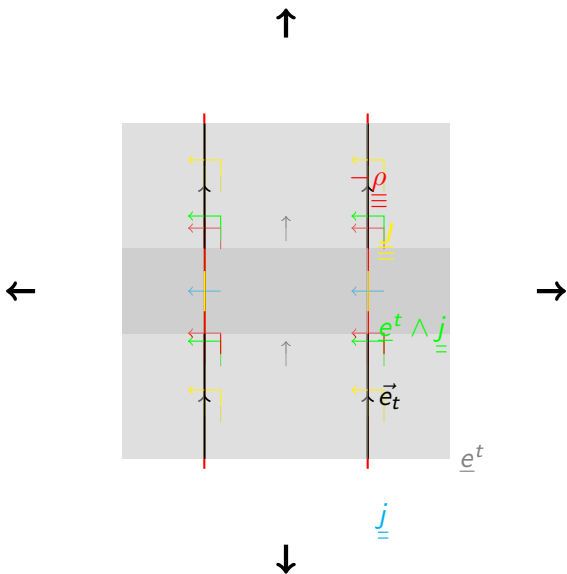

Figure 1.3.3 : An illustration of the 3+1 decomposition of  $\underline{J}$  given in Eq. (1.3.21). One spatial dimension, and densities and orientations in that dimension, has been suppressed.

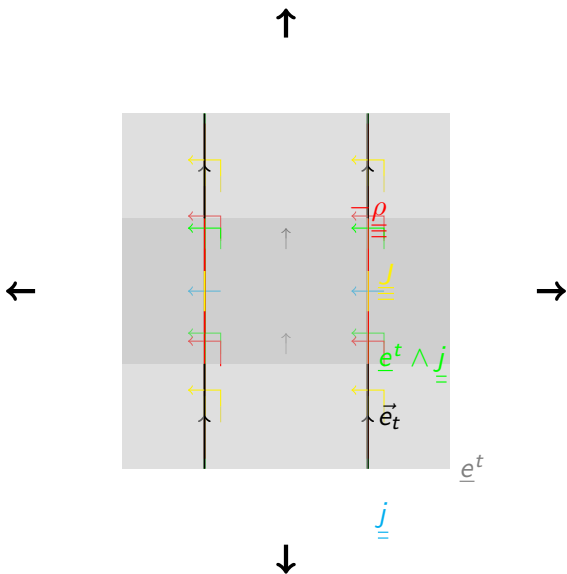

Figure 1.3.3 : An illustration of the 3+1 decomposition of  $\underline{J}$  given in Eq. (1.3.21). One spatial dimension, and densities and orientations in that dimension, has been suppressed.

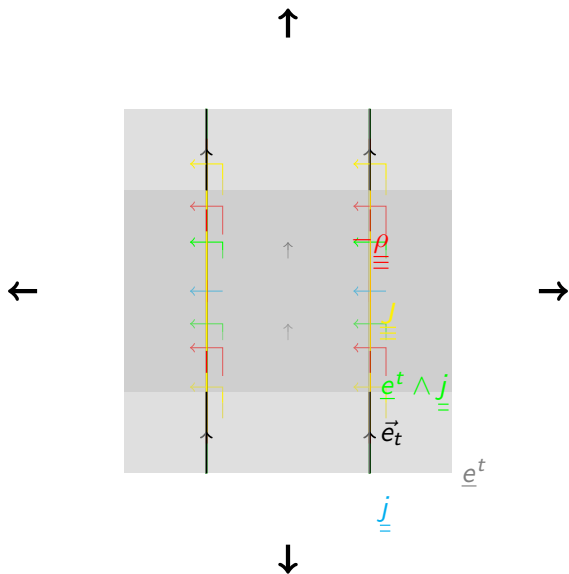

Figure 1.3.3 : An illustration of the 3+1 decomposition of  $\underline{\underline{J}}$  given in Eq. (1.3.21). One spatial dimension, and densities and orientations in that dimension, has been suppressed.

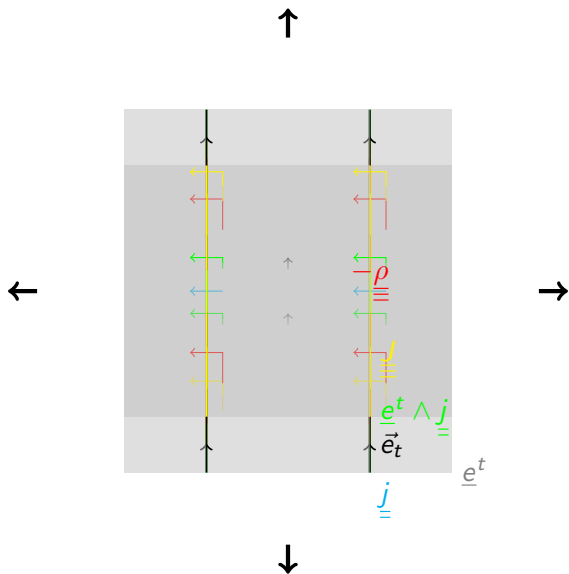

Figure 1.3.3 : An illustration of the 3+1 decomposition of  $\underline{\underline{J}}$  given in Eq. (1.3.21). One spatial dimension, and densities and orientations in that dimension, has been suppressed.

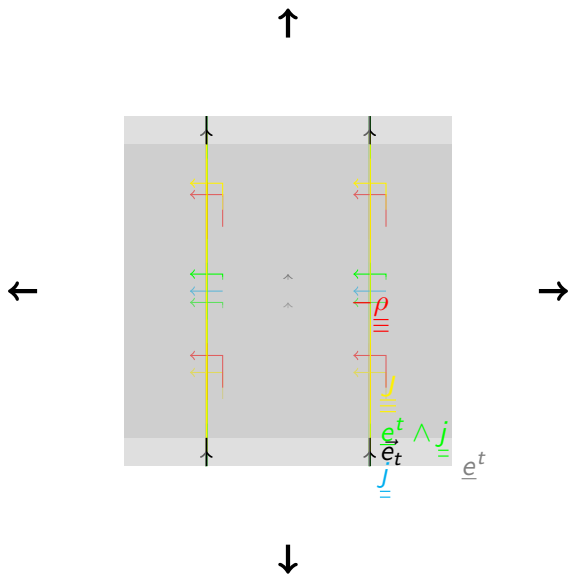

Figure 1.3.3 : An illustration of the 3+1 decomposition of  $\underline{\underline{J}}$  given in Eq. (1.3.21). One spatial dimension, and densities and orientations in that dimension, has been suppressed.

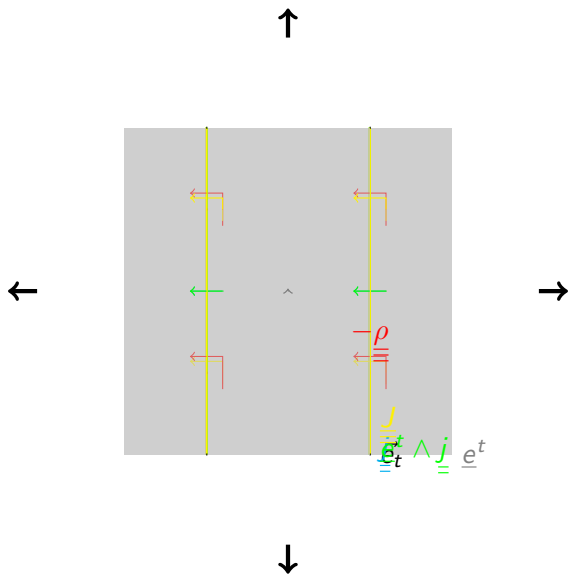

Figure 1.3.3 : An illustration of the 3+1 decomposition of  $\underline{\underline{J}}$  given in Eq. (1.3.21). One spatial dimension, and densities and orientations in that dimension, has been suppressed.

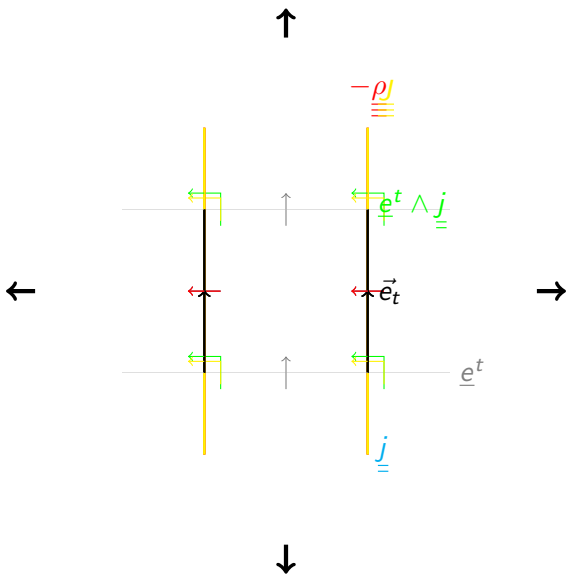

Figure 1.3.3 : An illustration of the 3+1 decomposition of  $\underline{J}$  given in Eq. (1.3.21). One spatial dimension, and densities and orientations in that dimension, has been suppressed.



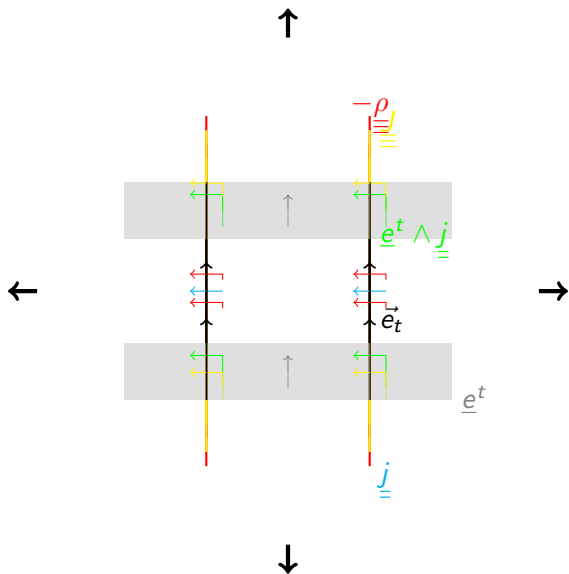

Figure 1.3.3 : An illustration of the 3+1 decomposition of  $\underline{\underline{J}}$  given in Eq. (1.3.21). One spatial dimension, and densities and orientations in that dimension, has been suppressed.

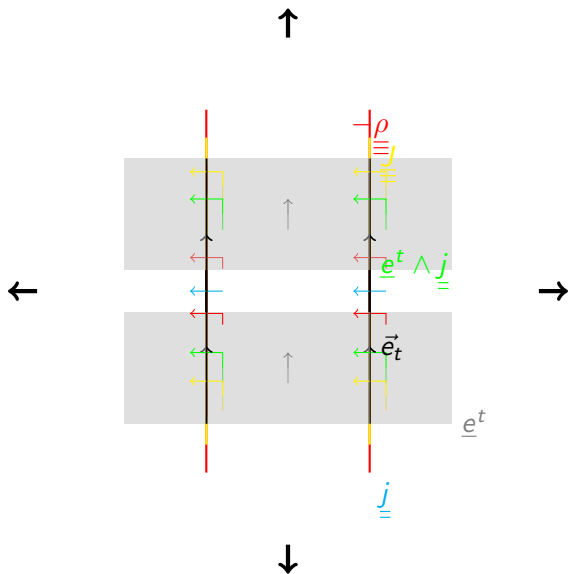

Figure 1.3.3 : An illustration of the 3+1 decomposition of  $\underline{J}$  given in Eq. (1.3.21). One spatial dimension, and densities and orientations in that dimension, has been suppressed.

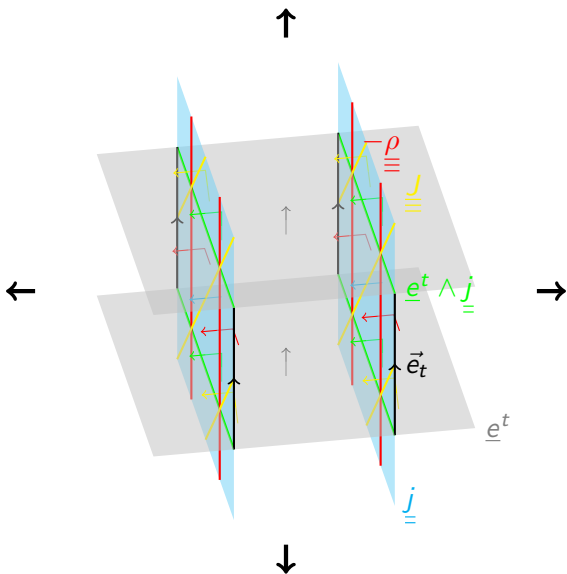

Figure 1.3.3 : An illustration of the 3+1 decomposition of  $\underline{J}$  given in Eq. (1.3.21). One spatial dimension, and densities and orientations in that dimension, has been suppressed.

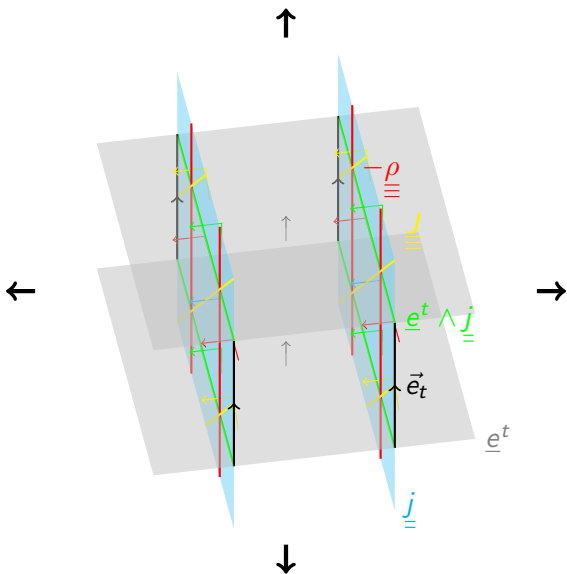

Figure 1.3.3 : An illustration of the 3+1 decomposition of  $\underline{\underline{J}}$  given in Eq. (1.3.21). One spatial dimension, and densities and orientations in that dimension, has been suppressed.

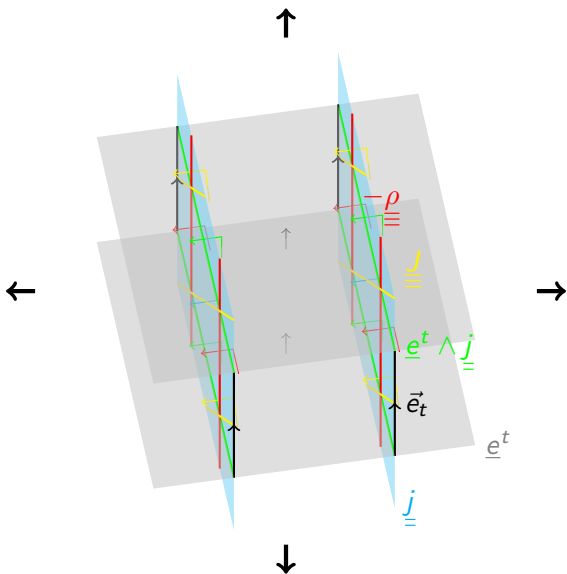

Figure 1.3.3 : An illustration of the 3+1 decomposition of  $\underline{j}$  given in Eq. (1.3.21). One spatial dimension, and densities and orientations in that dimension, has been suppressed.

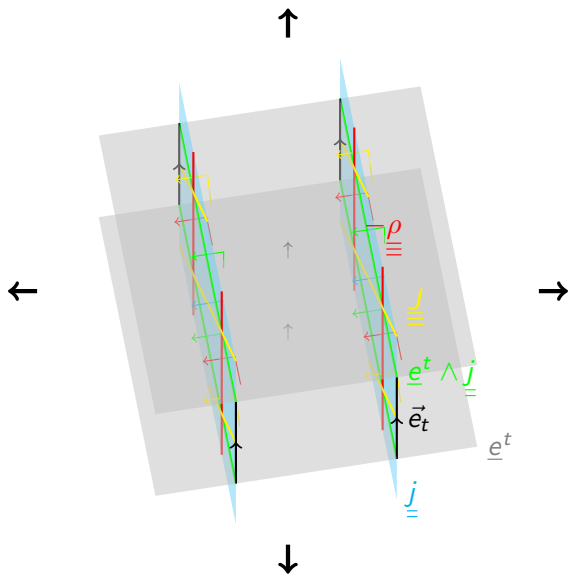

Figure 1.3.3 : An illustration of the 3+1 decomposition of  $\underline{J}$  given in Eq. (1.3.21). One spatial dimension, and densities and orientations in that dimension, has been suppressed.

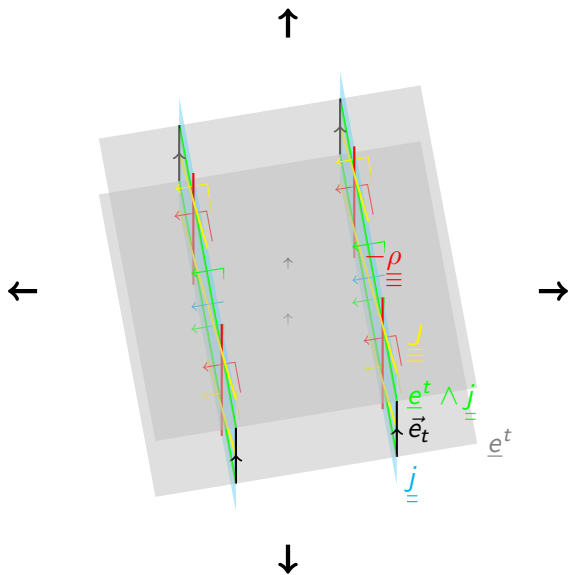

Figure 1.3.3 : An illustration of the 3+1 decomposition of  $\underline{\underline{J}}$  given in Eq. (1.3.21). One spatial dimension, and densities and orientations in that dimension, has been suppressed.

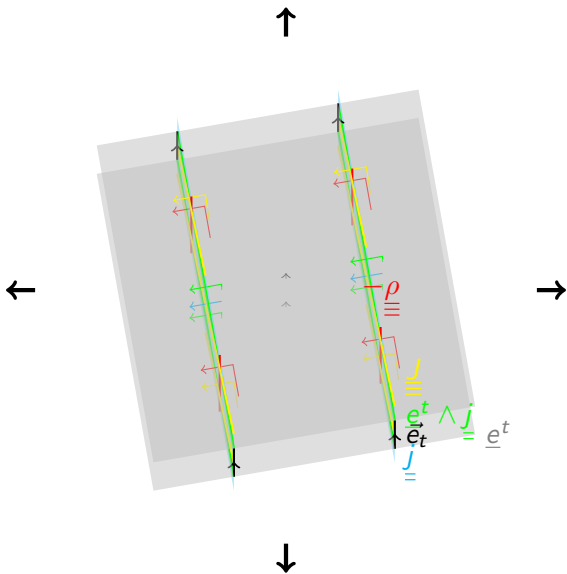

Figure 1.3.3 : An illustration of the 3+1 decomposition of  $\underline{J}$  given in Eq. (1.3.21). One spatial dimension, and densities and orientations in that dimension, has been suppressed.



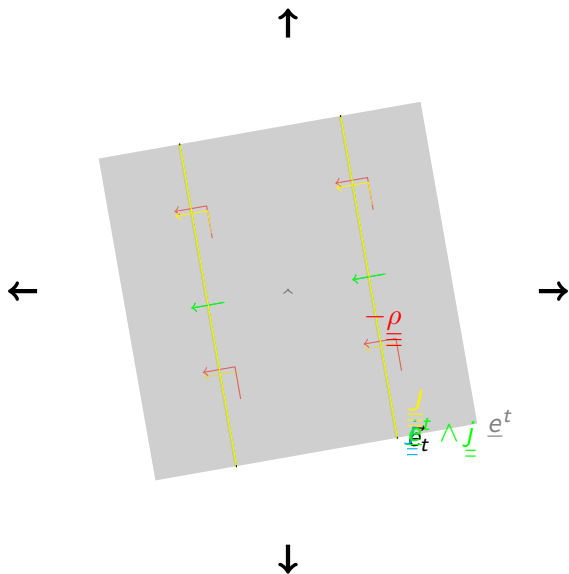

Figure 1.3.3 : An illustration of the 3+1 decomposition of  $\underline{\underline{J}}$  given in Eq. (1.3.21). One spatial dimension, and densities and orientations in that dimension, has been suppressed.

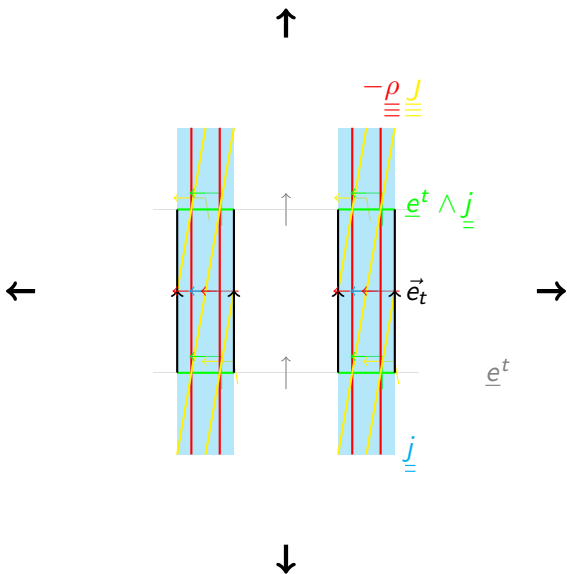

Figure 1.3.3 : An illustration of the 3+1 decomposition of  $\underline{\underline{J}}$  given in Eq. (1.3.21). One spatial dimension, and densities and orientations in that dimension, has been suppressed.

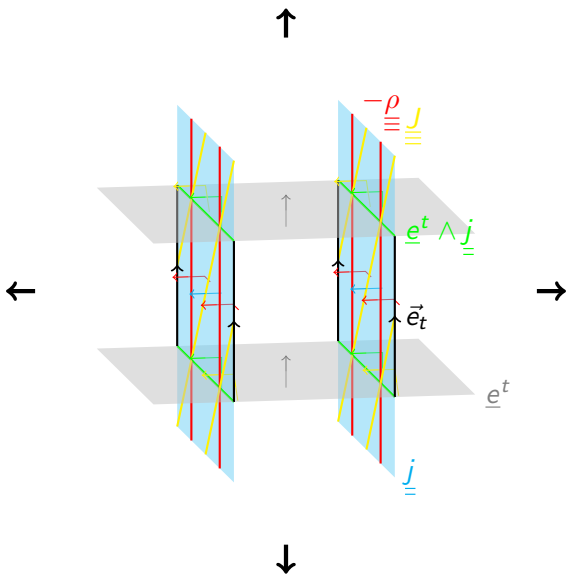

Figure 1.3.3 : An illustration of the 3+1 decomposition of  $\underline{J}$  given in Eq. (1.3.21). One spatial dimension, and densities and orientations in that dimension, has been suppressed.

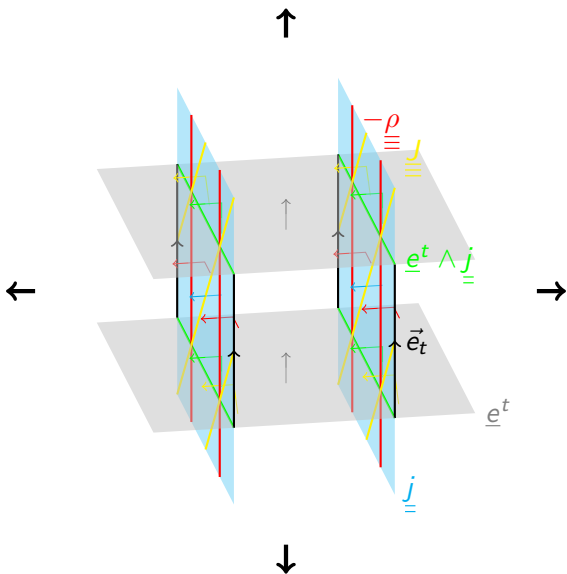

Figure 1.3.3 : An illustration of the 3+1 decomposition of  $\underline{\underline{J}}$  given in Eq. (1.3.21). One spatial dimension, and densities and orientations in that dimension, has been suppressed.

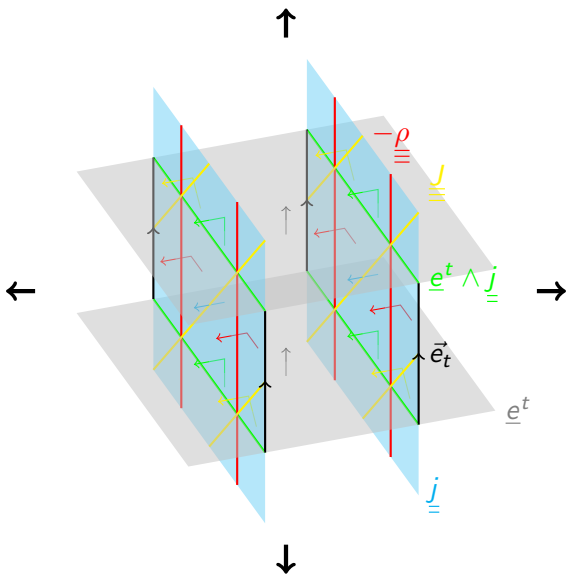

Figure 1.3.3 : An illustration of the 3+1 decomposition of  $\underline{\underline{J}}$  given in Eq. (1.3.21). One spatial dimension, and densities and orientations in that dimension, has been suppressed.

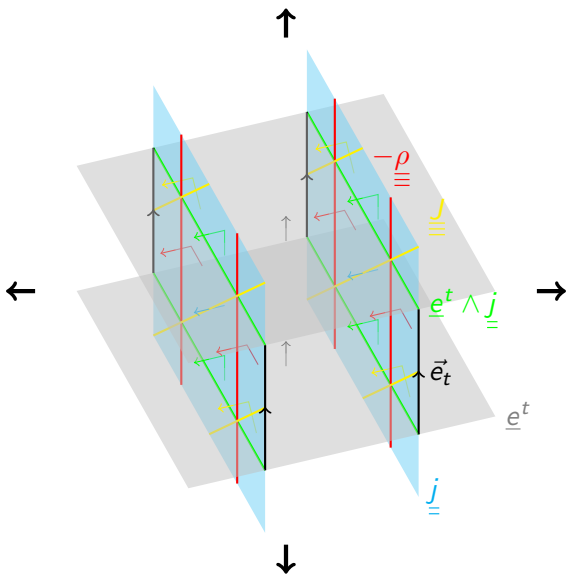

Figure 1.3.3 : An illustration of the 3+1 decomposition of  $\underline{\underline{J}}$  given in Eq. (1.3.21). One spatial dimension, and densities and orientations in that dimension, has been suppressed.

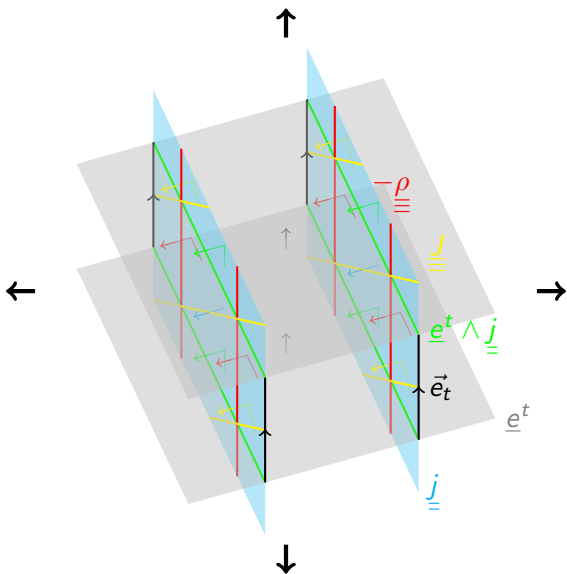

Figure 1.3.3 : An illustration of the 3+1 decomposition of  $\underline{J}$  given in Eq. (1.3.21). One spatial dimension, and densities and orientations in that dimension, has been suppressed.

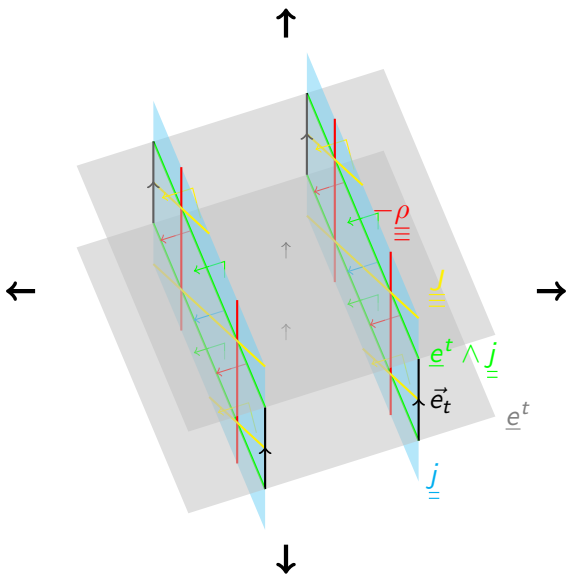

Figure 1.3.3 : An illustration of the 3+1 decomposition of  $\underline{\underline{J}}$  given in Eq. (1.3.21). One spatial dimension, and densities and orientations in that dimension, has been suppressed.



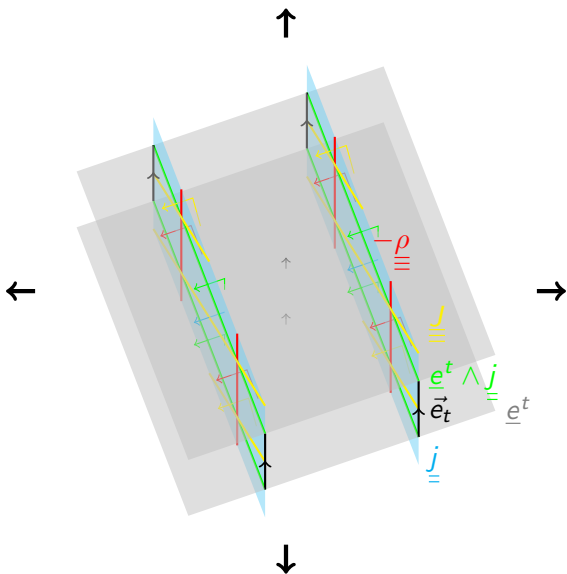

Figure 1.3.3 : An illustration of the 3+1 decomposition of  $\underline{j}$  given in Eq. (1.3.21). One spatial dimension, and densities and orientations in that dimension, has been suppressed.

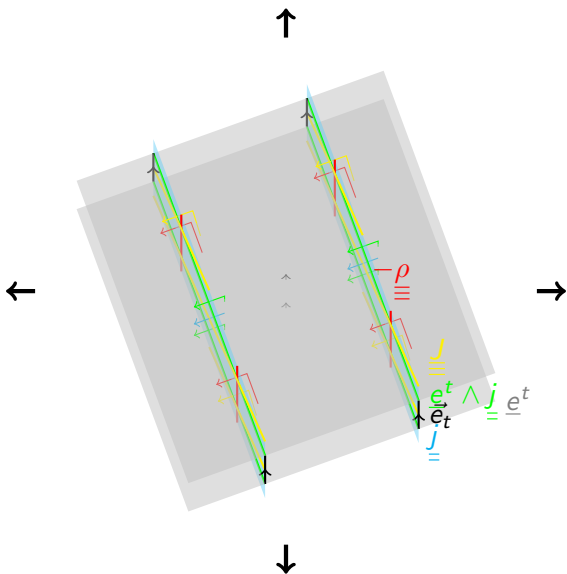

Figure 1.3.3 : An illustration of the 3+1 decomposition of  $\underline{\underline{J}}$  given in Eq. (1.3.21). One spatial dimension, and densities and orientations in that dimension, has been suppressed.

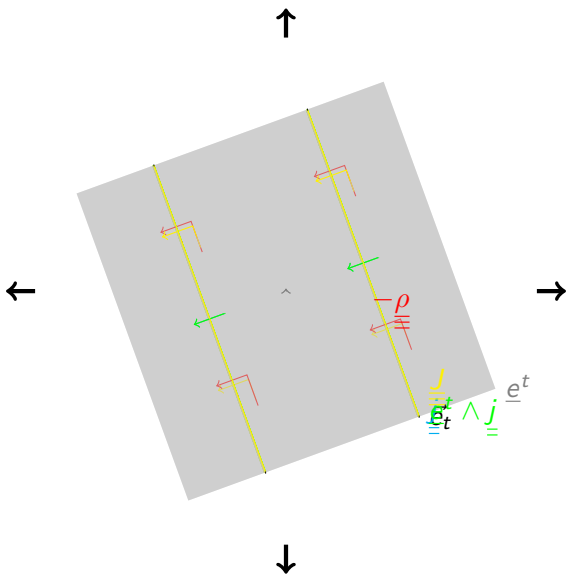

Figure 1.3.3 : An illustration of the 3+1 decomposition of  $\underline{\underline{J}}$  given in Eq. (1.3.21). One spatial dimension, and densities and orientations in that dimension, has been suppressed.

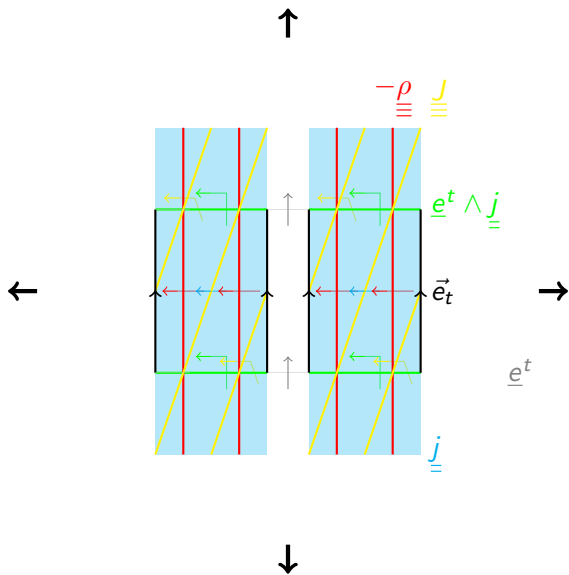

Figure 1.3.3 : An illustration of the 3+1 decomposition of  $\underline{\underline{J}}$  given in Eq. (1.3.21). One spatial dimension, and densities and orientations in that dimension, has been suppressed.

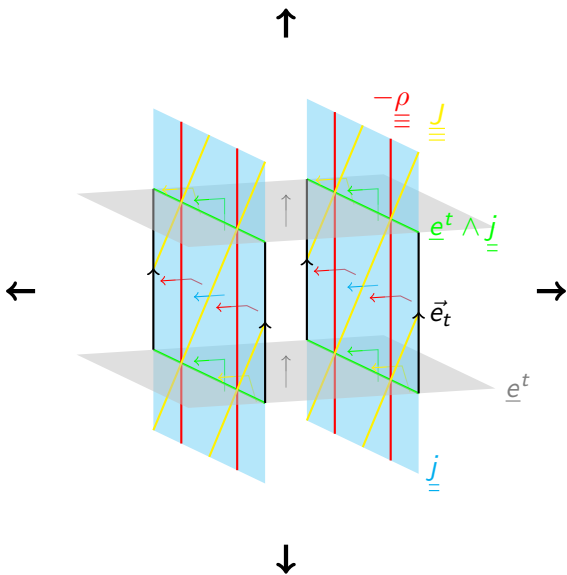

Figure 1.3.3 : An illustration of the 3+1 decomposition of  $\underline{J}$  given in Eq. (1.3.21). One spatial dimension, and densities and orientations in that dimension, has been suppressed.

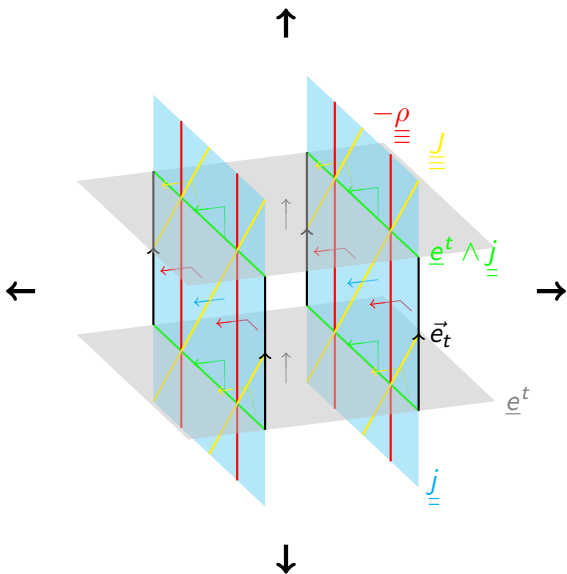

Figure 1.3.3 : An illustration of the 3+1 decomposition of  $\underline{\underline{J}}$  given in Eq. (1.3.21). One spatial dimension, and densities and orientations in that dimension, has been suppressed.